

The safe way to be seen



FAHRZEUG KENNZEICHNUNG VEHICLE MARKING

1: ADR



2: ZETTEL / LABELS



3: ECE 70-01

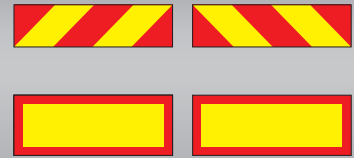

4: ECE 69-01

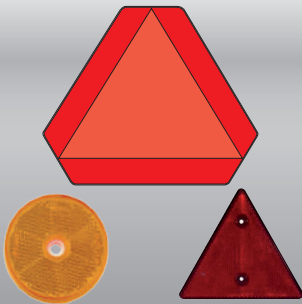

5: ÜBERBREITE / OVERSIZE



6: LED ÜBERBREITE / OVERSIZE

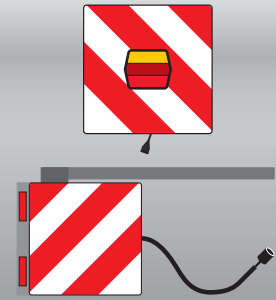

7: WARNUNG / WARNING

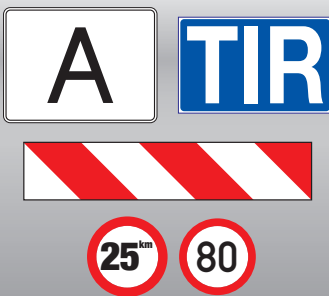

8: TRANSPORT



9: ECE 104-C

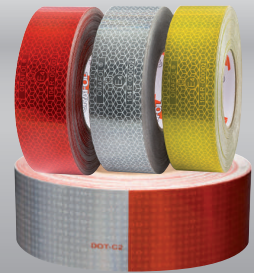

Grundlegende Regelwerke / Requirements

Zulassung von Fahrzeugen:

Nationale Zulassung in Deutschland:

- auf Grundlage der StvZO
- § 21a gewährleistet, dass Zulassungen oder Prüfzeichen aufgrund internationaler Abkommen (z. B. UNECE) anerkannt werden müssen

ODER DIREKT

Internationale Zulassung zur Anerkennung in Deutschland:

- Auf Grundlage der ECE Regulierungen
- ECE 48 für Fahrzeuge Klasse M, N, O
- ECE 86-01 für Fahrzeuge der Klasse T, R, S

Fahrzeugklassen:

- M: Fahrzeuge zur Personenbeförderung (Busse, Wohnmobile etc) M1: bis 8 Sitzplätze Fahrer
- M2: mehr als 8 Sitzplätze, bis 5 Tonnen M3: mehr als 8 Sitzplätze, über 5 Tonnen
- N: Fahrzeuge zur Güterbeförderung (Lkw, Lieferwagen)
- N1: bis 3,5 Tonnen
- N2: größer 3,5 bis 12 Tonnen
- N3: größer 12 Tonnen
- O: Anhänger und Sattelaufleger
- O1: bis 0,75 Tonnen
- O2: größer 0,75 bis 3,5 Tonnen
- O3: größer 3,5 bis 10 Tonnen
- O4: größer 10 Tonnen
- R: Land- und forstwirtschaftliche Anhänger
- S: gezogene oder angebaute Land- oder Forstmaschinen
- T: land- oder forstwirtschaftliche Zugmaschinen

Gesetzliche Regelungen der Fahrzeugmarkierungen (D):

DIN 67520 Ausgabe Oktober 2013: Retroreflektierende Materialien zur Verkehrssicherung- Lichttechnische Mindestanforderungen an Reflexstoffe

Regelt Mindestanforderungen an den spezifischen Rückstrahlwert
Anwendungsbereich: Verkehrszeichen und Verkehrseinrichtungen außerhalb der EN 12899

DIN 6171-1 Ausgabe Oktober 2013: Aufsichtsfarben für Verkehrszeichen und Verkehrseinrichtungen

Teil 1: Farbbereiche bei Beleuchtung mit Tageslicht

Regelt Anforderungen an Farbe bei Tag
Anwendungsbereich: Verkehrszeichen und Verkehrseinrichtungen außerhalb der EN 12899

DIN 11030 Ausgabe September 1994: Kenntlichmachung von Anbaugeräten und angehängten Arbeitsgeräten - Warntafel und Warnfolie

Regelt Anforderungen an Warntafeln und Warnfolien hinsichtlich Abmessungen, Anzahl und Form; verweist bezüglich Farbe auf DIN 6171 und hinsichtlich der Rückstrahlwerte auf DIN 67520 (Typ 1 oder Typ 2)

DIN 30710 Ausgabe März 1990: Sicherheitskennzeichnung von Fahrzeugen und Geräten

Für aus weißen und roten Flächen bestehende Warneinrichtung für Fahrzeuge, Geräte, sowie für Teile von Fahrzeuganbauten oder -aufbauten. Gilt für Warnfolien und Warntafeln; Regelt Abmessungen, Form und Gestaltung; verweist bezüglich Farbe auf DIN 6171 und hinsichtlich der Rückstrahlwerte auf DIN 67520 (nur Typ 2 erlaubt!)

Technische Anforderungen an Fahrzeugteile bei der Bauartprüfung nach § 22a StvZO (TA) Nr. 18b (Park-Warntafel)

Gilt nur für Warntafeln; Regelt Abmessungen (Form A: 423mm x 423mm, Form B: 282mm x 282mm)
Gestaltung und Funktion (klappbar!); Gibt Mindestrückstrahlwerte an und verweist bezüglich Farbe auf Gütebedingungen für VZ

UNECE R70: Einheitliche Bedingungen für Zulassung von Warntafeln für schwere und lange Fahrzeuge

Gilt nur für Warntafeln; Regelt Anforderungen an Gestaltung, Tagfarbe, Nachtfarbe, Rückstrahlwerte /Widerstand gegenüber Reinigung und Chemikalien, mechanische Stabilität des Trägermaterials; erlaubt:

- Klasse 1: retrorefl. Gelb / fluo. Rot für Lkw und Zugmaschinen
- Klasse 2: retrorefl. Gelb / fluo. Rot für Anhänger und Auflieger
- Klasse 3: retrorefl. Gelb/retrorefl. Rot für Lkw und Zugmaschinen
- Klasse 4: retrorefl. Gelb/retrorefl. Rot für Anhänger und Auflieger
- Klasse 5: retrorefl. Weiß/retrorefl. Rot für alle Fahrzeuge

UNECE R104: Einheitliche Bedingungen für Zulassung von Warnmarkierung für Fahrzeuge der Klasse M, N und O

Gilt nur für Warnfolien; Regelt Anforderungen an Gestaltung, Mindestflächen, Nachtfarbe Rückstrahlwerte, Widerstand gegenüber Reinigung und Chemikalien; erlaubt

- Klasse C streifenförmige Konturmarkierung mit Breite >50mm
- Klasse D für Applikation an der Fahrzeugseite <2m²
- Klasse E für größere Applikation
- Klasse F schraffierte Warnmarkierung rot/weiß

Approval of vehicles:

National regulations or directly through International regulations:

- Regulation ECE 48 for vehicle category M, N, O
- Regulation ECE 86 for vehicle category T, R, S

Category of vehicles:

- M vehicles for passenger transport (busses)
- M1 up to 8 passengerseats + driver
- M2 more than 8 passengerseats, up to 5 Tn
- M3 more than 8 passengerseats, more than 5 Tn
- N vehicles for transport of goods (trucks)
- N1 up to 3,5 Tn
- N2 from 3,5 to 12 Tn
- N3 as of 12 Tn
- O trailer and semitrailers
- O1 up to 750 kg
- O2 from 750 kg to 3,5 Tn
- O3 from 3,5 to 10 Tn
- O4 as of 10 Tn
- R agricultural trailers
- S agricultural semitrailers, trailed machinery
- T motorized agricultural vehicles

Mandated regulations regarding vehicle marking:

DIN 67520 Retroreflective materials for traffic safety - Light technical minimum requirements for reflective markers.

Regulates minimum requirements for the specific reflectance value. Scope: Traffic signs and traffic facilities outside of EN 12899

DIN 6171-1 Supervision colors for traffic signs and traffic facilities Part 1: Color ranges when illuminated with daylight.

Regulates color requirements for daytime Area of application: Traffic signs and traffic facilities outside of EN 12899.

DIN 11030 Identification of hauled vehicles (trailers) - warning signs and warning foil. Regulates requirements for warning signs and warning foils in terms of dimensions, number and shape; refers to DIN 6171 in terms of color and DIN 67520 (Type 1 or Type 2) in terms of the reflectance values

DIN 30710 Identification of special vehicles and appliances.

For warning devices consisting of white and red surfaces for vehicles, equipment, as well as for parts, parts of vehicle attachments or superstructures. Applies to warning foils and warning signs; Regulates dimensions, shape and design; Refers to DIN 6171 regarding color and DIN 67520 (only type 2 allowed!) regarding the reflectance values.

Technical requirements for vehicle parts in the type test according to § 22a StVZO (TA), No. 18b (parking warning sign).

Only applies to warning signs; Controls dimensions (shape A: 423mm x 423mm, shape B: 282mm x 282mm), design and function (hinged!); Specifies minimum reflectance values and refers to color quality conditions for VZ

UNECE-R70 Uniform conditions for approval of warning plates for heavy and long vehicles.

Only applies to warning signs; Regulates design requirements, day color, night color, reflectance values, resistance to cleaning and chemicals, mechanical stability of the panel. Following classes are issued :

- Class 1: retrorefl. Yellow / fluo Red for trucks and tractors
- Class 2: retrorefl. Yellow / fluo Red for trailer and semi-trailer
- Class 3: retrorefl. Yellow / retrorefl. Red for trucks and tractors
- Class 4: retrorefl. Yellow / retrorefl. Red for trailer and semi-trailer
- Class 5: retrorefl. White / retrorefl. Red for all vehicles

UNECE-R104 Standard conditions for the approval of warning marking for vehicles of category M, N and O.

Only applies to warning foils; Regulates design requirements, minimum surface area, night color, reflectance values, resistance to cleaning and chemicals; allowed:

- Class C strip-shaped contour marking with width >50mm
- Class D for application on the vehicle side <2m²
- Class E for larger applications
- Class F chevron warning mark red / white

Specifications...

5.3.2 Orange-coloured plate marking

5.3.2.1 General orange-coloured plate marking provisions

5.3.2.2.1 Transport units carrying dangerous goods shall display two rectangular orange-colored plates conform to 5.3.2.2.1, set in a vertical plane. They shall be affixed one at the front and the other at the rear of the transport unit, both perpendicular to the longitudinal axis of the transport unit. They shall be clearly visible.

5.3.2.2 Specifications for the orange-coloured plates

5.3.2.2.1 The orange-coloured plates shall be reflective and shall be of 40 cm base and of 30 cm height. They shall have a black border of 15 mm wide. The material used shall be weather-resistant and ensure durable marking. The plate shall not become detached from its mount in the event of 15 minutes engulfment in fire. It shall remain affixed irrespective of orientation of the vehicle. The orange-coloured plates may be separated in their middle with a black horizontal line of 15 mm thickness.

If the size and construction of the vehicle are such that the available surface area is insufficient to affix these orange-coloured plates, their dimensions may be reduced to a minimum of 300 for the base, 120 mm for the height and 10 mm for the back border. In this case, a different set of dimensions within the specified range may be used for the two orange-coloured plates specified in 5.3.2.1.1

When reduced dimensions of orange-coloured plates are used for a packaged radioactive material carried under exclusive use, only the UN number is required and the size of the digits stipulated in 5.3.2.2.2 may be reduced to 65 mm in height and 10 mm in stroke thickness.

For containers carrying dangerous solid substances in bulk and for tank-containers, MEGCs and portable tanks, the plates prescribed in 5.3.2.1.2, 5.3.2.1.4 and 5.3.2.1.5 may be replaced by a self-adhesive sheet, by paint or by any other equivalent process. This alternative marking shall be conform resistance to fire mentioned in 5.3.2.2.1 and 5.3.2.2.2.

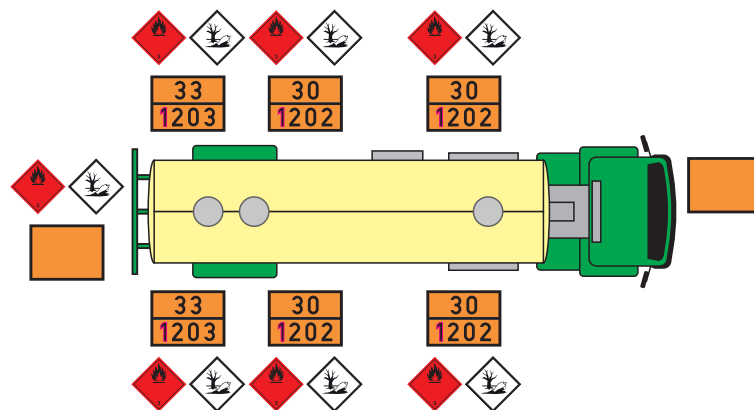

5.3.2.2.2 The hazard identification number and the UN number shall consist of black digits 100 mm high and of 15 mm stroke thickness. The hazard-identification number shall be inscribed in the upper plate and the UN number in the lower part, they shall be separated by a horizontal black line, 15 mm in stroke width, extending from side to side of the plate at mid-height (see 5.3.22.3) The hazard identification number and the UN number shall be indelible and shall remain legible after 15 minutes engulfing in fire. Interchangeable numbers and letters on plates presenting the hazard identification number and the UN number shall remain in place during carriage and irrespective of the orientation of the vehicle

Specifications...

5.3.2.2.3 Example of orange-coloured plate with hazard identification number and UN number

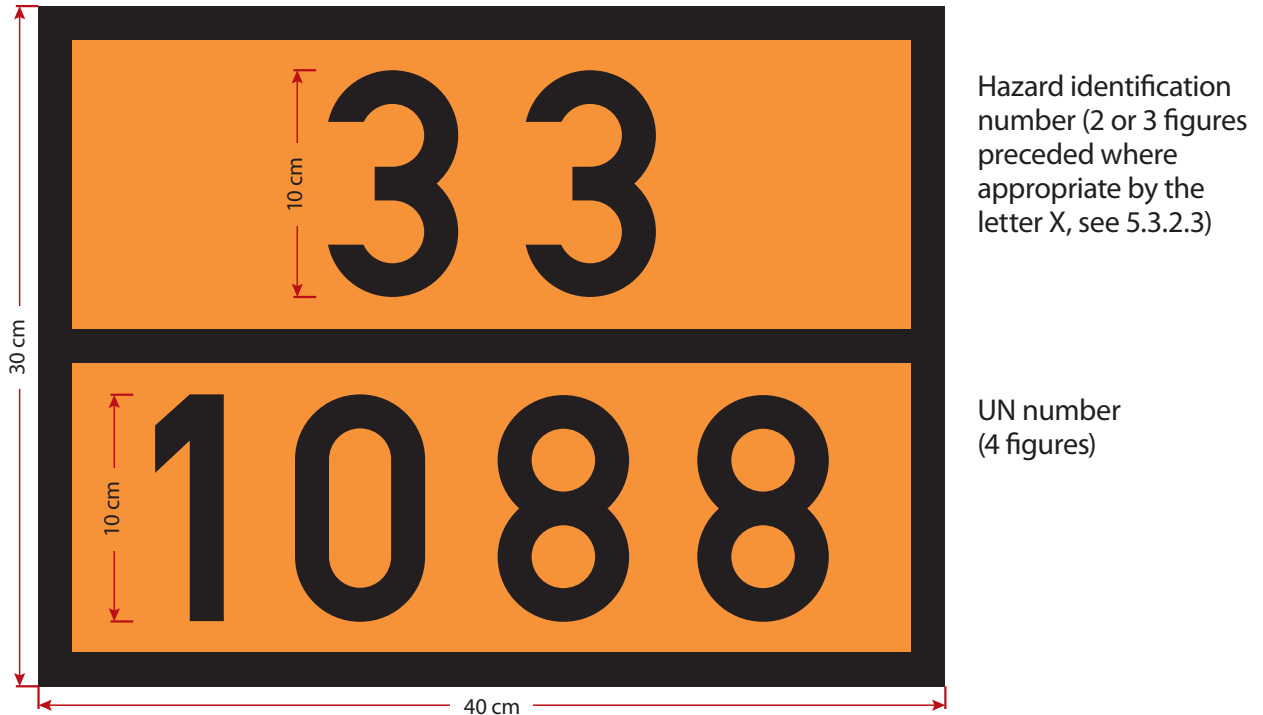

Background: Orange

Border, horizontal line and figures: Black, 15 mm thickness

5.3.2.2.4 the permitted tolerances for dimensions specified in this sub-section are $\pm 10\%$

5.3.2.2.5 When the orange-coloured plate is affixed to folding panels, they shall be designed and secured so that they can not unfold or come loose from the holder during carriage (especially as a result of impacts or unintentional actions).

5.3.2.3 Meaning of hazard identification numbers:

5.3.2.3.1 The hazard identification number consists of two or 3 figures. In general the figures indicate the following hazards:





- 1 Risk of explosion
- 2 Emission of gas due to pressure or to chemical reaction
- 3 Flammability of liquids (vapours) and gases or self-heating liquid
- 4 Flammability of solids or self-heating solid
- 5 Oxidizing (fire-intensifying) effect
- 6 Toxicity or risk of infection
- 7 Radioactivity
- 8 Corrosivity
- 9 Risk of spontaneous violent reaction





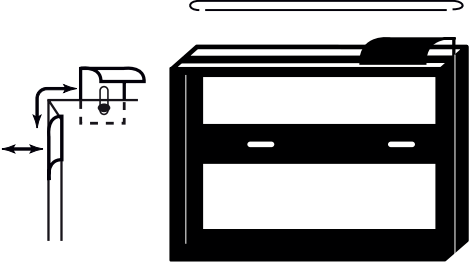
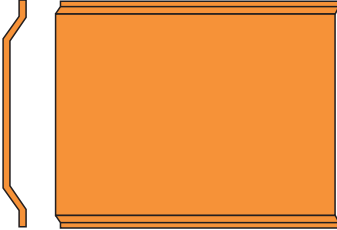



Zubehör / Accessories

Art. Nr.	Kennzeichnung / Description	Abbildung / Sample
30.003.00	Abdeckhaube für Wechseltafel groß, Stoff, braun <i>Cover for interchangeable sign big, fabric, brown</i>	
30.005.00	Abdeckhaube für ADR starr, 400x300mm, Stoff, braun <i>Cover for standard ADR sign, 400x300mm, fabric, brown</i>	
30.004.00	Abdeckhaube für ADR Wechseltafel, 400x300mm, Glasfaser Feuerfest, extra Klettband <i>Unflammable cover for interchangeable ADR 400x300mm, velcro</i>	
30.002.00	Abdeckhaube für ADR starr, 400x300mm, Glasfaser Feuerfest, extra Klettband <i>Unflammable cover for sign, velcro</i>	
30.007.00	Lose Zifferntasche für ADR Ziffern, 135x117mm, Stoff, braun <i>Separate bag for ADR-digits, 135x117mm, fabric, brown</i>	
30.008.00	Lose Dokumententasche, 400x260mm, grau, Klettband <i>Separate polyester documentholder, 400x260mm, grey, velcro</i>	
31.103.00	Wechselhalterung 400x300x1mm ohne Clips, Aluminium, ganz schwarz lackiert <i>Plateholder 400x300x1mm, without clips, aluminium, black</i>	
35.103.00	Wechselhalterung 400x300x0,8mm ohne Clips, Edelstahl, Seiten schwarz <i>Plateholder 400x300x0,8mm, without clips, stainless steel</i>	
35.103.82	Wechselhalterung 400x300x0,8mm mit 2 Clips, Edelstahl, Seiten schwarz für ADR Tafel, gemäß ADR § 5.3.2.2 <i>Plateholder 400x300x0,8mm, with clips stainless steel, black edges</i>	 
35.104.00	Loser Einschub (1x) für Halterung, 375x135mm, Edelstahl, schwarzer Rand (2 St. sind benötigt pro Halterung) <i>Separate slide (1x) for use in above plateholder, 375x135mm, stainless steel, black border (2 pcs. needed per plateholder)</i>	

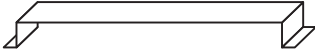
Zubehör / Accessories

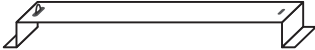
Art. Nr.	Kennzeichnung / Description	Abbildung / Sample
35.230.81	Wechselhalterung 300x120x0,8mm mit 1 Clip, Edelstahl, Seiten schwarz <i>Plateholder 300x120x0,8mm + 1 Clip, stainless steel, black border</i>	
35.098.01	Halterung 400x300x1,5mm für ca. 3 Tafel Edelstahl, schwarz, mit Clip <i>Plateholder 400x300x1,5mm + 1 Clip, for 3 signs, stainless steel, black</i>	
35.102.00	Voll-Adapter für Wechseltafel 35.100.00 Mazon 375x300mm, Edelstahl <i>Orange coverplate (bent) for the use in interchangeable signs 35.100.00, 375x300mm, stainless steel</i>	
35.007.00	Lose Arretierbolze für Wechseltafel Mazon, Edelstahl <i>Closingbolt for locking the brackets on interchangeable signs stainless steel</i>	
35.105.00	Adapter für Wechseltafel, Mazon, mit Ösen, damit kleine Ziffern 117x70mm, reingesteckt werden können. Edelstahl <i>Adapterplate for interchangeable signs for placing small digits</i>	
35.123.00	Loser Einschub (1x) für Wechseltafel Mazon Edelstahl, 375 x 135 mm, orange <i>Separate orange plate (no holes) for the use on interchangeable signs</i>	
35.124.00	Loser Einschub (1x) für Wechseltafel Mazon Edelstahl, 375 x 135 mm, mit Kodierung nach Wahl <i>Separate orange plate with pressjoined code of choice</i>	

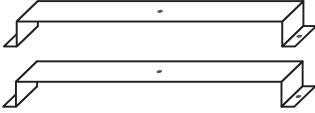
Zubehör / Accessories

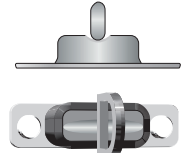
Art. Nr.	Kennzeichnung / Description	Abbildung / Sample
32.005.00	Loser Montagebügel für ein starres Schild, 400x300mm, in 2mm Aluminium <i>Bracket in 2mm aluminium for mounting of flat sign 400x300mm</i>	
35.005.00	Loser Montagebügel für ein starres Schild, 400x300mm, in 0,8mm Edelstahl <i>Bracket in 0,8mm stainless steel for mounting of flat sign 400x300mm</i>	
32.006.00	Loser Montagebügel für ein klappbares Schild, 400x300mm, in 2mm Aluminium <i>Bracket in 2mm aluminium for mounting of foldable sign 400x300mm</i>	
35.006.00	Loser Montagebügel für ein klappbares Schild, 400x300mm, in 0,8mm Edelstahl <i>Bracket in 0,8mm stainless steel for mounting of foldable sign 400x300mm</i>	
33.004.00	Satz (2 Stück) Montagebügel für ein starres Schild, 400x300mm, in 1mm Stahl, mit je 3 Löchern ø9mm <i>Set of 2 brackets in 1mm steel for mounting of flat sign 400x300mm with 3 holes ø9mm</i>	
89.075.00	Kantenschutz, schwarz, für 1mm und 2mm Tafel Pro laufenden Meter (z.B.: 10 Stück = 1 Rolle van 10 m ¹) <i>Protectionedge, black, for 1mm en 2mm plates, per ungoing meter (for example: 10 pcs. = 1 roll of 10 m¹)</i>	
89.068.1X	Loser Drehverschluss (1x), standard (groß), Schließung für klappbares Schild, Edelstahl <i>Turnstile (1x), standard (big) for fixing foldable panels, stainless steel</i>	



TUV-GEPRÜFT

Zifferntafel / Digit signs

Art. Nr.	Kennzeichnung / Description		Abbildung / Sample
35.100.00	Wechseltafel, Edelstahl mit fester Montageplatte an der Rückseite montiert <i>Interchangeable ADR sign with complete fixing bracket mounted</i> <small>(für Ziffern 135mm Edelstahl / for digits 135mm stainless steel)</small>		
35.101.00	Wechseltafel, Edelstahl mit 4 Langlöchern <i>Interchangeable ADR sign with 4 conclaved mountingholes</i> <small>(für Ziffern 135mm Edelstahl / for digits 135mm stainless steel)</small>		
35.099.01	Wechseltafel, Edelstahl mit 2 Bügeln an der Rückseite montiert <i>Interchangeable ADR sign with 2 brackets</i> <small>(für Ziffern 135mm Edelstahl / for digits 135mm stainless steel)</small>		
35.108.00	Ziffersatz in Tasche, 37 Teilig 135x93,5x0,5mm, Edelstahl mit Loch <i>Digitset 37 pcs. in bag 135x93,5x0,5mm, stainless steel with hole</i> (3x 0-5; 4x 6; 3x 7; 3x 8; 1x X; 8x blanko)		
35.128.00	Ziffersatz in Tasche, 27 Teilig 135x93,5x0,5mm, Edelstahl mit Loch <i>Digitset 27 pcs. in bag 135x93,5x0,5mm, stainless steel with hole</i> (2x 0; 3x 1-3; 2x 4-5; 4x 6; 2x 7; 3x 8; 1x X; 2x blanko)		
35.129.00	Ziffersatz in Tasche, 27 Teilig 117x70x0,5mm, Edelstahl <i>Digitset 27 pcs. in bag 117x70x0,5mm, stainless steel</i> (2x 0; 3x 1-3; 2x 4-5; 4x 6; 2x 7; 3x 8; 1x X; 2x blanko)		



TUV-GEPRÜFT

Ziffern / Digits

Art. Nr.	Kennzeichnung / Description Lose Zifferplatine / Single digits	Abbildung / Sample
35.110.00	0	
35.111.00	1	
35.112.00	2	
35.113.00	3	
35.114.00	4	
35.115.00	5	
35.116.00	6 / 9	
35.117.00	7	
35.118.00	8	
35.119.00	X	
35.120.00	orange	

Edelstahl 135 x 93,5 x 0,5 mm
Stainless steel 135 x 93,5 x 0,5 mm

33.130.00	0	
33.131.00	1	
33.132.00	2	
33.133.00	3	
33.134.00	4	
33.135.00	5	
33.136.00	6 / 9	
33.137.00	7	
33.138.00	8	
33.139.00	X	
33.140.00	orange	

Stahlblech 117 x 70 x 1 mm
Steel 117 x 70 x 1 mm

Zifferntafel / *Interchangeable sign*

Art. Nr.

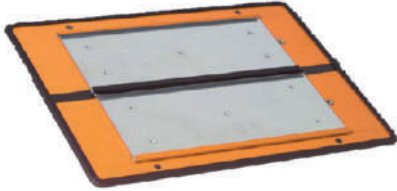
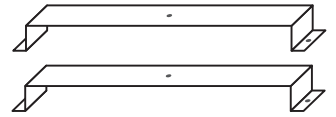
Kennzeichnung / *Description*
für Ziffern 117mm / *for 117mm digits*Abbildung / *Sample*starr / *flat*klappbar / *foldable*

33.099.03

Ziffertafel starr / *Interchangeable sign flat*
Stahlblech / *zincplated steel*
 Mit 2 montierten Bügeln, mit umlaufenden Kantenschutz
With 2 mounted brackets, with protection edge

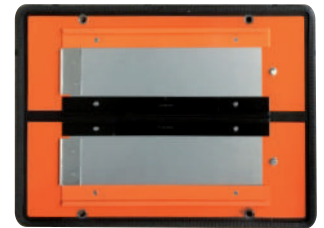

33.096.03

Ziffertafel klappbar / *Interchangeable sign foldable*
Stahlblech / *zincplated steel*
 Mit 2 montierten Bügeln, mit umlaufenden Kantenschutz
With 2 mounted brackets, with protection edge



33.129.00

Ziffersatz in Tasche, 27 Teilig, 117x70x1mm, Stahl
Digitset in bag, 27 pieces, 117x70x1mm, steel
 (2x 0; 3x 1-3; 2x 4-5; 4x 6; 2x 7; 3x 8; 1x X; 2x blanko)



33.143.00

Einzelne orange Platine in 117x280mm /
Full digitplate orange in 117x280mm
 Voll-Einsatzstück (1x) Stahlblech, orange
 L = 280mm (2x benötigt für Zifferntafel)
Full digitplate (1x), steel, orange
 L = 280mm (2x needed for interchangeable sign)





Tafel: orange reflektierend / Sign: orange reflective

Art. Nr.	Kennzeichnung / Description	Abbildung / Sample
400x300x1mm Galvalume mit Edelstahl Ziffern, mit Druckfügen 400x300x1mm Galvalume with stainless steel digits, with pressure joints		
38.150.00	Einstoff Kodierungstafel 30/1202 <i>ADR sign 30/1202</i>	
38.150.02	Einstoff Kodierungstafel 30/1202 mit Kantenschutz <i>ADR sign 30/1202, with protectionedge</i>	
38.151.00	Einstoff Kodierungstafel 30/1223 <i>ADR sign 30/1223</i>	
38.151.02	Einstoff Kodierungstafel 30/1223 mit Kantenschutz <i>ADR sign 30/1223, with protectionedge</i>	
38.152.00	Einstoff Kodierungstafel 33/1203 <i>ADR sign 33/1203</i>	
38.152.02	Einstoff Kodierungstafel 33/1203 mit Kantenschutz <i>ADR sign 33/1203, with protectionedge</i>	
38.154.00	Einstoff Kodierungstafel 23/1965 <i>ADR sign 23/1965</i>	
38.154.02	Einstoff Kodierungstafel 23/1965 mit Kantenschutz <i>ADR sign 23/1965, with protectionedge</i>	
38.199.00	Einstoff Kodierungstafel - Jede andere Kodierung <i>ADR sign - with any other code</i>	Beispiel:
38.199.02	Einstoff Kodierungstafel - Jede andere Kodierung mit Kantenschutz <i>ADR sign - with any other code, with protectionedge</i>	
38.190.00	Zweistoff Kodierungstafel (Benzin / Heizöl) 30/1202 + 33/1203 <i>ADR 2-in-1 sign 30/1202 + 33/1203</i>	
38.190.02	Zweistoff Kodierungstafel (Benzin / Heizöl) 30/1202 + 33/1203 mit Kantenschutz <i>ADR 2-in-1 sign 30/1202 + 33/1203, with protectionedge</i>	



Kodierungstafel reflektierend

Orange retroreflective ADR sign with unerasable code. Dimensions: 400 x 300 x 1 mm. Fully comply and even exceeds current ADR requirements. Recognizable during and after fire. New generation ADR signs in full compliance with ADR regulations. Galvanneel with stainless-steel pressjoined digits.

- Withstands minimal 30 minutes of fire engulfment
- Corrosion resistant materials
- Withstands fire of min. 900°C
- Readable from minimal 30 M distance
- Patented

Recognizable during and after fire



Current embossed ADR



ADR NEW after fire



- Art.nr. 38.190.00

ADR NEW GENERATION 2-in 1 codesign
Petrol / Diesel: 30/1202 + 33/1203
Including 4 spacers for mounting holes
(excl Screws)
Turnable overlay-plate (180°) with strong spring.
Easy and quick in use.

Galvan: highly corrosion resistant !



Peel-off transparent protective foil on all digits



Coding sign reflective

Neue Generation ADR Warntafel konform alle Anforderungen der ADR Regulierung. Galfanstahl mit Druckfügeziffern von VA-Stahl. Entspricht und übertrifft heutige ADR Anforderungen. Orangefarbig retroreflektierende ADR Tafel mit unlösbarer Kodierung. Abmessung 400x300x1 mm

- Widersteht minimal 30 Minuten Feuer
- Korrosionvorbeugende Materialien
- Widersteht ein Feuer von minimal 900°C
- Lesbar von minimal 30 M Entfernung
- Patentiert

Nach und während Feuer Erkennbar

patentiert



Heutige geprägte ADR



ADR NEU nach einem feuer



- Art.nr. 38.190.00

ADR NEUE GENERATION Zweistofftafel
Benzin / Heizöl: 30/1202 + 33/1203
inklusive 4 Abstandhalter für
4 Befestigungslöchern (excl. Schrauben).
Drehbare Metallplatte (180°) mit starkem Feder.
Einfach und leicht anzuwenden.

Galfan: stark korrosionvorbeugend !



Schutzfolie an Ziffern entfernenbar



Tafel: orange reflektierend / Sign: orange reflective

Art. Nr.	Kennzeichnung / Description	Abbildung / Sample
----------	-----------------------------	--------------------

400x300x1mm Galvalume mit Edelstahl Ziffern, mit Druckfugen
 400x300x1mm Galvalume with stainless steel digits, with pressure joints

38.298.00	Horizontal klappbar / Horizontally foldable Einstoff Kodierungstafel - Jede andere Kodierung ADR sign - with any other code	Beispiel:
38.298.02	Einstoff Kodierungstafel - Jede andere Kodierung mit Kantenschutz ADR sign - with any other code, with protectionedge	

38.299.00	Vertikal klappbar / Vertically foldable Einstoff Kodierungstafel - Jede andere Kodierung ADR sign - with any other code	Beispiel:
38.299.02	Einstoff Kodierungstafel - Jede andere Kodierung mit Kantenschutz ADR sign - with any other code, with protectionedge	

ADR Tafel - Beispiel - SPANIEN

Ausnahme Europa: ADR Tafel Spanien / ADR Spain:

- Homologierte Typ 2 Wabenfolie (V2)
- Rand geprägt / embossed edge
- Homologationsnummer: V11.118

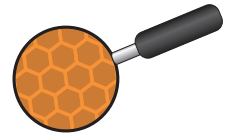

Typ 2 Wabenfolie mit Marke V2
Class 2 foil with V2 watermark

38.399.00	Einstoff Kodierungstafel SPANIEN mit Kodierung Orange Typ 2 Folie, geprägter Rand und Homologationsnummer ADR code sign SPAIN , class 2 foil and homologationnumber	
-----------	---	--

38.301.00	ADR Tafel SPANIEN , Orange, Horizontal klappbar / hor. foldable Orange Typ 2 Folie, geprägter Rand und Homologationsnummer ADR sign SPAIN , class 2 foil and homologationnumber	
38.302.00	ADR Tafel SPANIEN , Orange, Vertikal klappbar / vert. foldable Orange Typ 2 Folie, geprägter Rand und Homologationsnummer ADR sign SPAIN , class 2 foil and homologationnumber	

38.300.00	ADR Tafel SPANIEN , Orange, Starr Orange Typ 2 Folie, geprägter Rand und Homologationsnummer ADR sign SPAIN , class 2 foil and homologationnumber	
-----------	---	--

Tafel: orange reflektierend / Sign: orange reflective

Art. Nr.

Kennzeichnung / Description

Abbildung / Sample

Hochreflex Prismatische Folie / high prismatic reflective

35.515.13

Höhere Beständigkeit Winterwetter (Z.b. Skandinavien)
 ADR 3-in-1 400x300x0,8mm Edelstahl mit Neutralteil
 in weiß und 3 Kodierungen:
 30/1202 - 33/1203 - 33/3475 - Orange Reflektierend
 mit Grundplatte
High resistance to impact and winterconditions (Scandinavia)
 ADR 3-in-1 400x300x0,8mm stainless steel
 With white neutral part when closed and 3 codes:
 30/1202 - 33/1203 - 33/3475 - orange Reflective baseplate

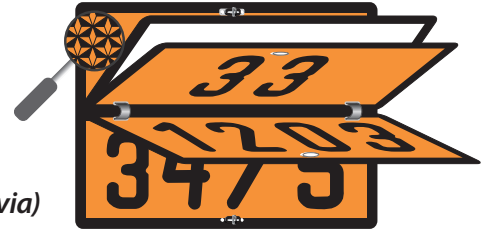

35.516.13

Höhere Beständigkeit Winterwetter (Z.b. Skandinavien)
 ADR 4-in-1 400x300x0,8mm Edelstahl mit Neutralteil
 in orange reflektierend und 3 Kodierungen:
 33/1202 - 33/1203 - 33/3475 - orange reflektierend
 mit Grundplatte
High resistance to impact and winterconditions (Scandinavia)
 ADR 4-in-1 400x300x0,8mm stainless steel
 With orange reflective neutral part when closed and 3 codes:
 33/1202 - 33/1203 - 33/3475 - orange Reflective baseplate

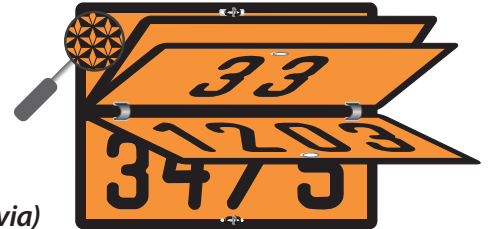

Kodierungstafel - Code sign - ENGLAND

35.195.00

ADR-Kombi-Tafel England
 Horizontal klappbar mit 3x Drehverschluß
 685x300x0,8mm Edelstahl
 2X/3291 i.K.m. Klasse 6.2 - Orange Reflektierend
 ADR combisign Great Britain,
 horizontally foldable, 685x300x0,8mm stainless steel
 2X/3291 Hazchem class 6.2. Orange reflective class 1

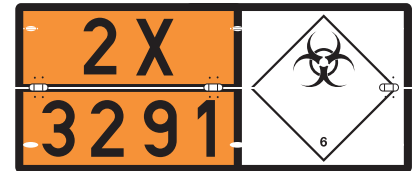

Kodierungstafel - Code sign - Benzin-Heizöl-Petroleum: alternative

33.180.14.17



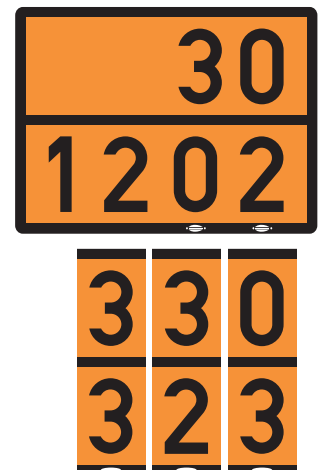

ADR BHP-Tafel mit separaten Overlay-Ziffern
 Stahlblech, mit 2 Montagelöchern und Kantenschutz
 Orange Reflektierend
 Alternative multi codesign ADR combisign with separate overlay plates
 zincplated steel. Orange reflective class 1

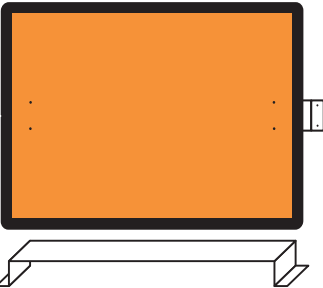
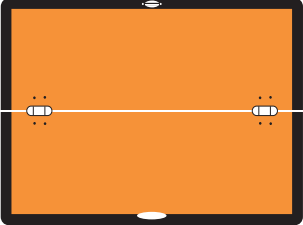

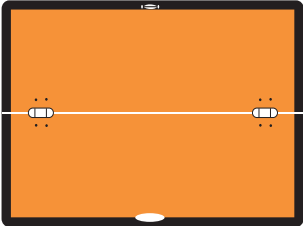

Tafel: orange reflektierend / Sign: orange reflective

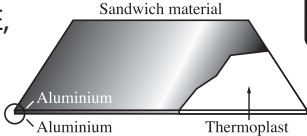
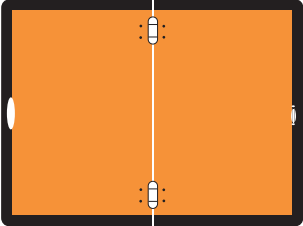
Art. Nr.	Kennzeichnung / Description	Abbildung / Sample
31.200.00	ADR starr, 400x300x1mm, Alu ADR sign flat, 400x300x1mm, alu	
31.200.02	ADR starr, 400x300x1mm, Alu mit Kantenschutz ADR sign flat, 400x300x1mm, alu with protectionedge	
32.200.00	ADR starr, 400x300x1mm, Alu ADR sign flat, 400x300x1mm, alu	
32.200.02	ADR starr, 400x300x1mm, Alu mit Kantenschutz ADR sign flat, 400x300x1mm, alu with protectionedge	
33.200.00	ADR starr, 400x300x1mm, Stahlblech ADR sign flat, 400x300x1mm, zincplated steel	
33.200.02	ADR starr, 400x300x1mm, Stahlblech mit Kantenschutz ADR sign flat, 400x300x1mm, zincplated steel with protectionedge	
35.200.00	ADR starr, 400x300x0,8mm, Edelstahl ADR sign flat, 400x300x0,8mm, stainless steel	
35.200.02	ADR starr, 400x300x0,8mm, Edelstahl mit Kantenschutz ADR sign flat, 400x300x0,8mm, stainless steel with protectionedge	
31.200.03	ADR starr, 400x300x1mm, Alu mit Kantenschutz montiert auf eine Halterung ADR sign flat, 400x300x1mm, alu with protectionedge and Bracket	
33.200.03	ADR starr, 400x300x1mm, Stahlblech mit Kantenschutz montiert auf eine Halterung ADR sign flat, 400x300x1mm, zincplated steel with protectionedge and Bracket	
31.201.00	ADR, 400x300x1mm, Alu, horizontal klappbar ADR, 400x300x1mm, alu horizontally foldable	
31.201.02	ADR, 400x300x1mm, Alu, horizontal klappbar mit Kantenschutz ADR, 400x300x1mm, alu horizontally foldable with protectionedge	
32.201.00	ADR, 400x300x2mm, Alu, horizontal klappbar ADR, 400x300x2mm, alu horizontally foldable	
32.201.02	ADR, 400x300x2mm, Alu, horizontal klappbar mit Kantenschutz ADR, 400x300x2mm, alu horizontally foldable with protectionedge	
33.201.00	ADR, 400x300x1mm, Stahlblech, horizontal klappbar ADR, 400x300x1mm, zincplated steel, horizontally foldable	
33.201.02	ADR, 400x300x1mm, Stahlblech, horizontal klappbar mit Kantenschutz ADR, 400x300x1mm, zincplated steel, horizontally foldable with protectionedge	

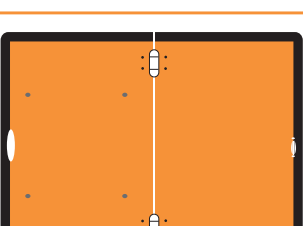
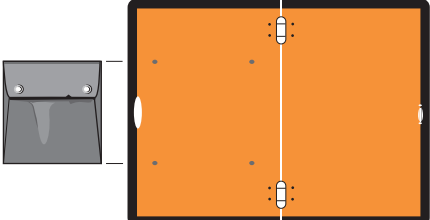

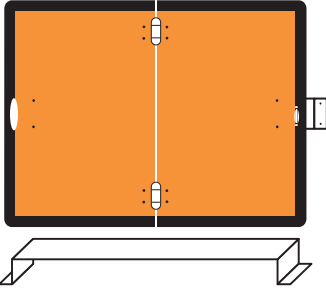
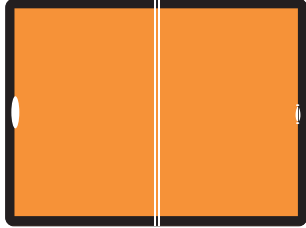
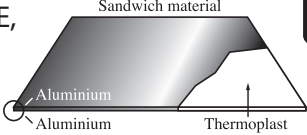

Tafel: orange reflektierend / Sign: orange reflective

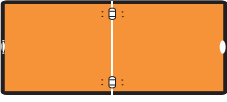
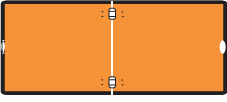
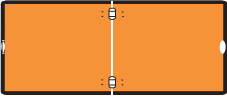
Art. Nr.	Kennzeichnung / Description	Abbildung / Sample
35.201.00	ADR hor. klappbar, 400x300x0,8mm, Edelstahl <i>ADR hor. foldable, 400x300x0,8mm, stainless steel</i>	
35.201.02	ADR hor. klappbar, 400x300x0,8mm, Edelstahl mit Kantenschutz <i>ADR hor. foldable, 400x300x0,8mm, stainless steel with protectionedge</i>	
23.201.00	ADR hor. klappbar, 400x300x1,2mm, HYLITE, ohne Metallscharnieren <i>ADR hor. foldable, 400x300x1,2mm, HYLITE without metal hinges</i>	
23.201.02	ADR hor. klappbar, 400x300x1,2mm, HYLITE, ohne Metallscharnieren, mit Kantenschutz <i>ADR hor. foldable, 400x300x1,2mm, HYLITE without metal hinges, with protectionedge</i>	
		
31.202.00	ADR vert. klappbar, 400x300x1mm, Alu <i>ADR vert. foldable, 400x300x1mm, alu</i>	
31.202.02	ADR vert. klappbar, 400x300x1mm, Alu mit Kantenschutz <i>ADR vert. foldable, 400x300x1mm, alu with protectionedge</i>	
32.202.00	ADR vert. klappbar, 400x300x2mm, Alu <i>ADR vert. foldable, 400x300x2mm, alu</i>	
32.202.02	ADR vert. klappbar, 400x300x2mm, Alu mit Kantenschutz <i>ADR vert. foldable, 400x300x2mm, alu with protectionedge</i>	
33.202.00	ADR vert. klappbar, 400x300x1mm, Stahlblech <i>ADR vert. foldable, 400x300x1mm, steel</i>	
33.202.02	ADR vert. klappbar, 400x300x1mm, Stahlblech mit Kantenschutz <i>ADR vert. foldable, 400x300x1mm, steel with protectionedge</i>	
35.202.00	ADR vert. klappbar, 400x300x0,8mm, Edelstahl <i>ADR vert. foldable, 400x300x0,8mm, stainless steel</i>	
35.202.02	ADR vert. klappbar, 400x300x0,8mm, Edelstahl mit Kantenschutz <i>ADR vert. foldable, 400x300x0,8mm, stainless steel with protectionedge</i>	
31.202.07	ADR vert. klappbar, 400x300x1mm, Alu mit Kantenschutz und mit Dokumenttasche montiert <i>ADR vert. foldable, 400x300x1mm, alu with protectionedge and with mounted documentholder</i>	





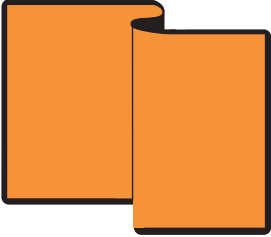
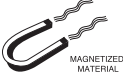
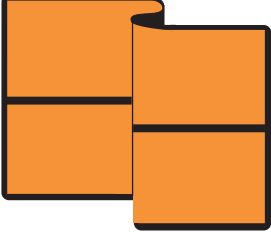
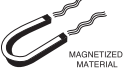
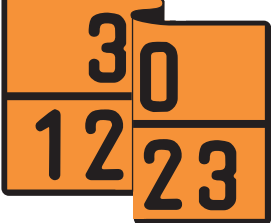





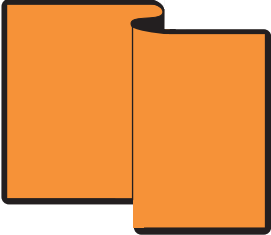

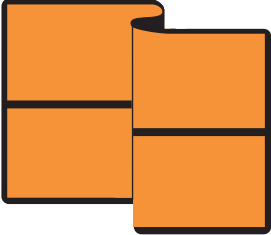

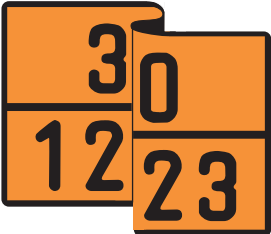

Tafel: orange reflektierend / Sign: orange reflective

Art. Nr.	Kennzeichnung / Description	Abbildung / Sample
31.202.01	ADR vert. klappbar, 400x300x1mm, Alu, mit Montagebügel <i>ADR vert. foldable, 400x300x1mm, alu, with mounted bracket</i>	
23.202.00	ADR vert. klappbar, 400x300x1,2mm, HYLITE, ohne Metallscharnieren <i>ADR vert. foldable, 400x300x1,2mm, HYLITE without metal hinges</i>	
23.202.02	ADR vert. klappbar, 400x300x1,2mm, HYLITE, ohne Metallscharnieren, mit Kantenschutz <i>ADR vert. foldable, 400x300x1,2mm, HYLITE without metal hinges, with protectionedge</i>	
31.220.00	ADR starr, 300x120x1mm, Alu <i>ADR flat, 300x120x1mm, alu</i>	
31.220.02	ADR starr, 300x120x1mm, Alu mit Kantenschutz <i>ADR flat, 300x120x1mm, alu with protectionedge</i>	
31.222.00	ADR vert. klappbar, 300x120x1mm, Alu <i>ADR vert. foldable, 300x120x1mm, alu</i>	
31.222.02	ADR vert. klappbar, 300x120x1mm, Alu mit Kantenschutz <i>ADR vert. foldable, 300x120x1mm, alu with protectionedge</i>	

Refl.: Aufkleber und Magnet / Refl.: sticker and magnetic

Art. Nr.	Kennzeichnung / Description	Abbildung / Sample
30.220.00	ADR, 300x120mm, Aufkleber ADR, 300x120mm, sticker	
30.220.27	ADR, 300x120x0,8mm, Magnetfolie ADR, 300x120x0,8mm, magnetic 	
30.200.00	ADR, 400x300mm, Aufkleber ADR, 400x300mm, sticker	
30.200.27	ADR, 400x300x0,8mm, Magnetfolie ADR, 400x300x0,8mm, magnetic 	
30.176.00	ADR, 400x300mm, Aufkleber mit Mittellinie ADR, 400x300mm, sticker with middleline	
30.176.27	ADR, 400x300x0,8mm, Magnetfolie mit Mittellinie ADR, 400x300x0,8mm, magnetic with middleline 	
30.199.00	ADR, 400x300mm, Aufkleber mit Kodierung nach Wahl ADR, 400x300mm, sticker with any code	
30.199.27	ADR, 400x300x0,8mm, Magnetfolie mit Kodierung nach Wahl ADR, 400x300x0,8mm, magnetic with any code 	

NICHT refl.: Aufkleber & Magnet / *NON refl: sticker & magnetic*

Art. Nr.	Kennzeichnung / Description	Abbildung / Sample
30.010.00	ADR, 400x300mm, Aufkleber, NICHT reflektierend - RID <i>ADR, 400x300mm, sticker, NON reflective - RID</i>	
30.010.27	ADR, 400x300x0,8mm, Magnetfolie, NICHT reflektierend - RID <i>ADR, 400x300x0,8mm, magnetic, NON reflective - RID</i>	
30.011.00	ADR, 400x300mm, Aufkleber mit Mittellinie NICHT reflektierend - RID <i>ADR, 400x300mm, sticker with middleline, NON reflective - RID</i>	
30.011.27	ADR, 400x300x0,8mm, Magnetfolie mit Mittellinie NICHT reflektierend - RID <i>ADR, 400x300x0,8mm, magnetic with middleline, NON reflective - RID</i>	
30.012.00	ADR, 400x300mm, Aufkleber mit Kodierung nach Wahl NICHT reflektierend - RID <i>ADR, 400x300mm, sticker with any code, NON reflective - RID</i>	
30.012.27	ADR, 400x300x0,8mm, Magnetfolie mit Kodierung nach Wahl, NICHT reflektierend - RID <i>ADR, 400x300x0,8mm, magnetic with any code NON reflective - RID</i>	
NICHT reflektierende, entfernbare RID Aufkleber 120x90mm für Art. Nr. 30.011.00 / 30.011.27 <i>NON reflective, removeable RID sticker 120x90mm for art. nr. 30.011.00 / 30.011.27</i>		
30.020.00	0	
30.021.00	1	
30.022.00	2	
30.023.00	3	
30.024.00	4	
30.025.00	5	
30.026.00	6 + 9	
30.027.00	7	
30.028.00	8	
30.029.00	X	
		

Meeres-Transport: ungeprägt/ *Seatransport: non-embossed*

Art. Nr.	Kennzeichnung / Description	Abbildung / Sample
35.510.00	ADR 2-in-1 400x300x0,8mm Edelstahl mit Neutralteil 58/2014 - 559/2015 In Siebdruck Orange Reflektierend mit Grundplatte ADR 2-in-1 400x300x0,8mm stainless steel with neutral part 58/2014 - 559/2015 in screenprint orange Reflective with baseplate	
35.514.00	ADR 4-in-1 400x300x0,8mm Edelstahl mit Neutralteil 58/2014 - 559/2015 - 58/3149 - 539/3109 In Siebdruck Orange Reflektierend mit Grundplatte ADR 4-in-1 400x300x0,8mm stainless steel with neutral part 58/2014 - 559/2015 - 58/3149 - 539/3109 in screenprint orange Reflective with baseplate	
35.502.00	ADR Zettel 2-in-1 250x250x0,8mm Edelstahl mit Neutralteil Zettel Klasse 5.1 und Klasse 5.2 mit Grundplatte Hazard label sign 2-in-1 250x250x0,8mm stainless steel with neutral part Class 5.1 and Class 5.2 with baseplate	
35.508.00	ADR Zettel, klappbar, 250x250x0,8mm Edelstahl mit Neutralteil Zettel Klasse 8 ohne Grundplatte Hazard label sign, foldable, 250x250x0,8mm stainless steel with neutral part, Class 8 without baseplate	
35.520.00	Tekst-Tafel 4-in-1 400x300x0,8mm Edelstahl mit Neutralteil 4 x Text In Siebdruck Text-sign 4-in-1 400x300x0,8mm stainless steel with neutral part 4 proper shipping names in screenprint	
35.540.00	ADR Zettel, klappbar, 250x250x0,8mm Edelstahl, Thermometer mit Grundplatte Hazard label sign, foldable, 250x250x0,8mm stainless steel Thermometer with full baseplate	
35.545.00	ADR Zettel, klappbar, 250x250x0,8mm Edelstahl, Klasse 5.1 mit Grundplatte Hazard label sign, foldable, 250x250x0,8mm stainless steel Class 5.1 with full baseplate	
35.547.00	ADR Zettel, klappbar, 250x250x0,8mm Edelstahl, Fisch-Baum (EHS) mit Grundplatte Hazard label sign, foldable, 250x250x0,8mm stainless steel fish-tree (EHS) with full baseplate	
35.548.00	ADR Zettel, klappbar, 250x250x0,8mm Edelstahl, Klasse 8 mit Grundplatte Hazard label sign, foldable, 250x250x0,8mm stainless steel Class 8 with full baseplate	
35.549.00	ADR Zettel, klappbar, 250x250x0,8mm Edelstahl, Klasse 9 mit Grundplatte Hazard label sign, foldable, 250x250x0,8mm stainless steel Class 9 with full baseplate	

Armee-Tafel / Nato sign

Art. Nr.

Kennzeichnung / Description

Abbildung / Sample

32.257.11

ADR 400x300x2mm Alu mit Halterung, hor. klappbar
 Armee-grün, Nato-Stock-Nr: 9905-17-109-9291
 ADR 400x300x2mm Alu with bracket, hor. foldable
 army-green, Nato-Stock-Nr: 9905-17-109-9291

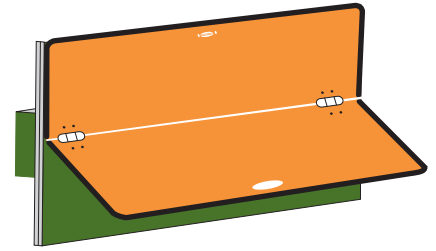

32.258.11

Satz von 4 Zetteln in Halterung, 321x321x2mm Alu
 4 beidseitig verklebte Tafeln, Klasse 1 explosive, Armee-grün
 Nato-Stock-Nr: 9905-17-109-9290
 Set of 4 hazardlabels in box, 321x321x2mm Alu
 4 doublesided panels, Class 1 explosive, armygreen
 Nato-Stock-Nr: 9905-17-109-9290

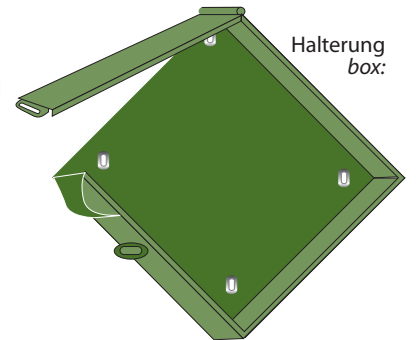

Inhalt/content:



30.280.00

Aufklebersatz der Kompatibilitätsgruppen in A4 Format
 Nato-Stock-Nr: 9905-17-109-9292
 Stickerset sub-groups in A4 format
 Nato-Stock-Nr: 9905-17-109-9292



Einige kurze Spezifikationen...

- 5.2.1.8.3 E.H.S.: Kein ADR Zettel, sondern Zusatz.
Anforderungen: Rand bis am Ende und mindestens 2mm dick.



The mark shall be in the form of a square set at an angle of 45° (diamond-shaped). The symbol (fish and tree) shall be black on white or suitable contrasting background. The minimum dimensions shall be 100x100 mm and the minimum width of the line forming the diamond shall be 2 mm. If the size of the package so requires, the dimensions/line thickness may be reduced, provided the mark remains clearly visible. Where dimensions are not specified, all features shall be in approximate proportion to those shown.

5.2.2.2 Provisions for labels

- 5.2.2.2.1 Labels shall satisfy the provisions below and conform, in terms of colour, symbols and general format, to the models shown in 5.2.2.2.2. Corresponding models required for other modes of transport, with minor variations which do not affect the obvious meaning of the label, are also acceptable.

- 5.2.2.2.1.1.2 The label shall be in the form of a square set at an angle of 45° (diamond-shaped). The minimum dimensions shall be 100x100mm and the minimum width of the line inside the edge forming the diamond shall be 2 mm. The line inside the edge shall be parallel and 5 mm from the outside of that line to the edge of the label. The line inside the edge on the upper half of the label shall be the same colour as the symbol and the line inside the edge on the lower half of the label shall be the same colour as the class or division number in the bottom corner. Where dimensions are not specified, all features shall be in approximate proportion to those shown.

5.3.1.7 Specifications for placards

- 5.3.1.7.1 Except as provided in 5.3.1.7.2 for the Class 7 placard, and in 5.3.6.2 for the environmentally hazardous substance mark, a placard shall be configured as shown in Figure 5.3.1.7.1.

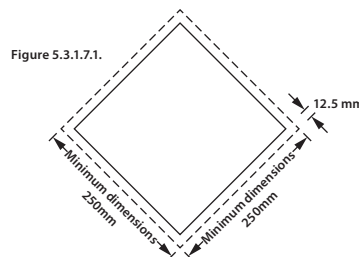

- 5.3.1.1.4 For Class 9 the placard shall correspond to the label model No.9 as in 5.2.2.2.2; label model No. 9A shall not be used for placarding purposes.

Zubehör/ Accessories

Art. Nr.

Kennzeichnung / Description

Abbildung / Sample

30.099.00

Schriftliche Weisungen ADR
aktuelles Jahr
(A3 in beidseitiges A4 Format)
ADR Instructions hazardclasses
(double A3 as A4 format)

SCHRIFTLICHE WEISUNGEN GEMÄSS ADR
Maßnahmen bei einem Unfall oder Notfall
2017 (gültig bis 30-06-2019)

Bei einem Unfall oder Notfall, der sich während der Beförderung ereignen kann, müssen die Mitglieder der Fahrzeugbesatzung folgende Maßnahmen ergreifen, sofern diese sicher und praktisch durchführbar sind:

- Bremsensystem betätigen, Motor abstellen und Batterie durch Bedienung des geeigneten vorhandenen Hauptzufuhrhebers;
- Zündquellen vermeiden, insbesondere nicht rauchen und keine elektrische Ausrüstung einschalten;
- Die entsprechenden Ersatzkaffe verständigen und dabei soweit Informationen wie möglich über den Unfall oder Zwischenfall und die betroffene Stoffe liefern;
- Warnweste anlegen und selbstbehaltende Warnzeichen an geeigneter Stelle aufklappen;
- Beförderungspapiere für die Ankunft der Ersatzkaffe bereit halten;
- Nicht in ausgasende Stoffe treten oder diese berühren und das Einatmen von Dunst, Rauch, Staub und Dämpfen durch Aufhalten auf der dem Wind zugewandten Seite vermeiden;
- Sofern dies gefahrlos möglich ist, Feuerlöscher verwenden, um kleine Brände / Erhitzungsbrände an Hüllen, Ölflecken und im Motorraum zu bekämpfen;
- Brände in Ladekabinen dürfen nicht von Mitgliedern der Fahrzeugbesatzung bekämpft werden;
- Sofern dies gefahrlos möglich ist, Bortausrüstung verwenden, um das Entleeren von Stoffen in Gewässer oder in Kanalisation zu verhindern und um ausgasende Stoffe einzudämmen;
- Sich aus der unmittelbaren Umgebung des Unfalls oder Notfalls entfernen, andere Personen anfordern sich zu entfernen und die Weisungen der Ersatzkaffe befolgen;
- Kontaminierte Kleidung und gebrauchte kontaminierte Schutzausrüstung aussuchen und sicher entsorgen.

1	2	3

Illustration Anwendung Kodierungstafel am Fahrzeug:
Illustration of appliance:

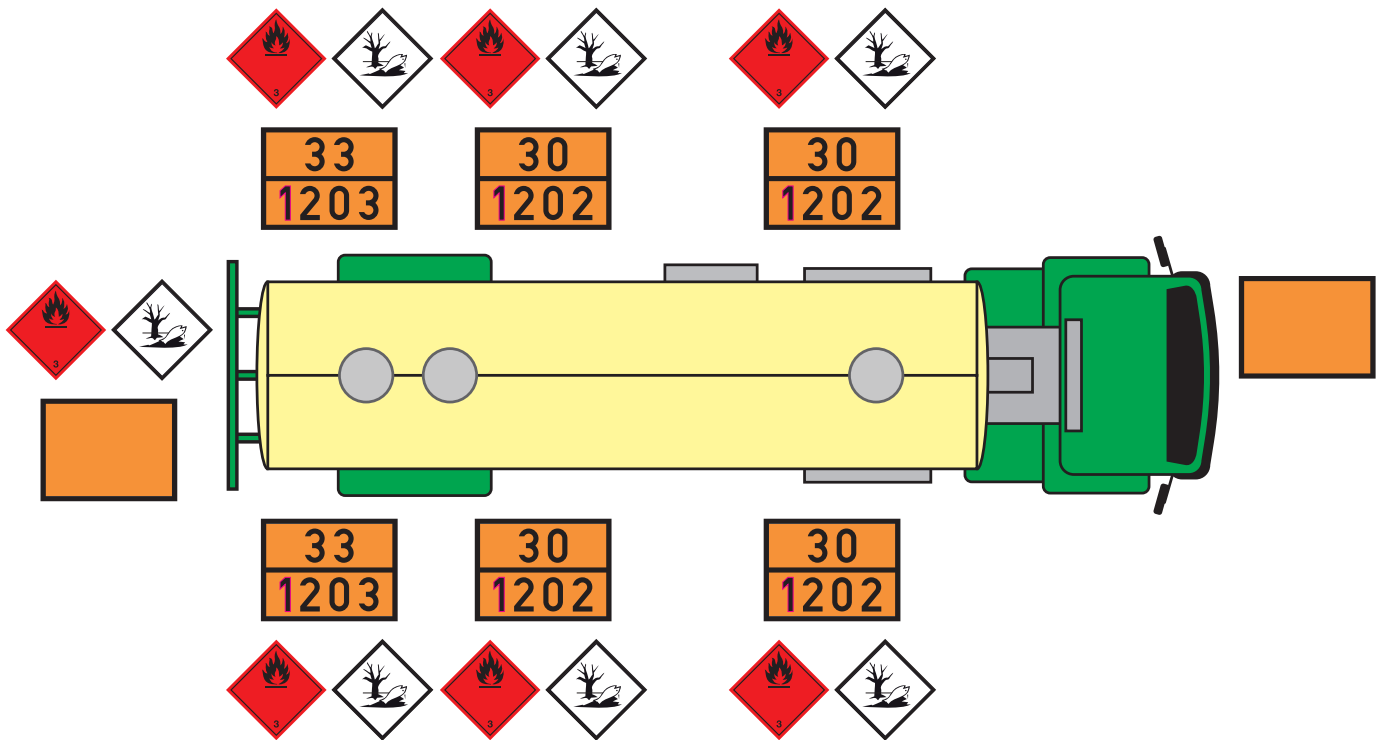

Zubehör/ Accessories

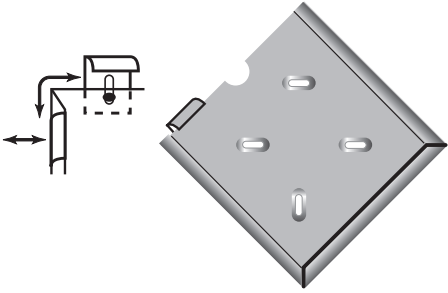
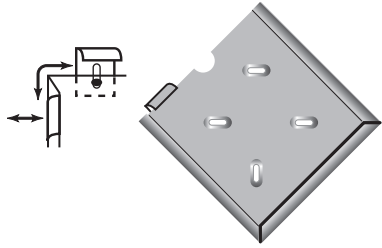
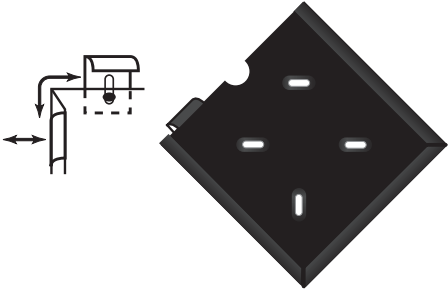
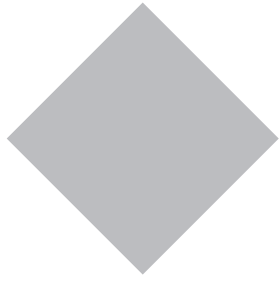
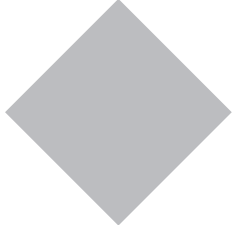
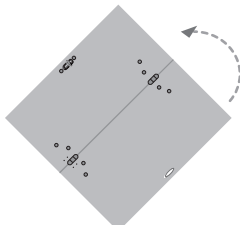
Art. Nr.	Kennzeichnung / Description	Abbildung / Sample
35.905.81	Wechselhalterung 300x300x0,8mm mit 1 Clip Edelstahl <i>Plateholder 300x300x0,8mm with 1 lockingclip stainless steel</i>	
33.905.81	Wechselhalterung 300x300x1mm mit 1 Clip Stahlblech <i>Plateholder 300x300x1mm with 1 lockingclip zincplated vsteel</i>	
35.903.81	Wechselhalterung 250x250x0,8mm mit 1 Clip, Edelstahl <i>Plateholder 250x250x0,8mm with 1 lockingclip, stainless steel</i>	
33.903.81	Wechselhalterung 250x250x1mm mit 1 Clip, Stahlblech <i>Plateholder 250x250x1mm with 1 lockingclip, zincplated steel</i>	
31.905.81	Wechselhalterung 300x300x1mm mit 1 Clip Alu, Schwarz lackiert <i>Plateholder 300x300x1mm with 1 lockingclip alu, painted black</i>	
Lose Untergründe ohne Zettel / Separate backgrounds without sticker		
26.902.00	300x300x2mm - Kunststoff (Forex) - <i>synthetic (Forex)</i>	
27.902.00	300x300x0,8mm - Magnetfolie - <i>magnetic</i>	
31.902.00	300x300x1mm - Aluminium - <i>Aluminum</i>	
32.902.00	300x300x2mm - Aluminium - <i>Aluminum</i>	
33.902.00	300x300x1mm - Stahlblech - <i>zincplated steel</i>	
35.902.00	300x300x0,8mm - Edelstahl - <i>stainless steel</i>	
Lose Untergründe ohne Zettel / Separate backgrounds without sticker		
26.906.00	250x250x2mm - Kunststoff (Forex) - <i>synthetic (Forex)</i>	
27.926.00	250x250x0,8mm - Magnetfolie - <i>magnetic</i>	
31.906.00	250x250x1mm - Aluminium - <i>Aluminum</i>	
32.906.00	250x250x2mm - Aluminium - <i>Aluminum</i>	
33.906.00	250x250x1mm - Stahlblech - <i>zincplated steel</i>	
Lose Untergründe ohne Zettel / Separate backgrounds without sticker		
31.921.00	300x300x1mm - diagonal klappbar Alu - <i>diagonally foldable Alu</i>	
31.922.00	300x300x1mm - horizontal klappbar Alu - <i>horizontally foldable Alu</i>	
31.923.00	250x250x1mm - diagonal klappbar Alu - <i>diagonally foldable Alu</i>	
31.924.00	250x250x1mm - horizontal klappbar Alu - <i>horizontally foldable Alu</i>	

Zubehör/ Accessories

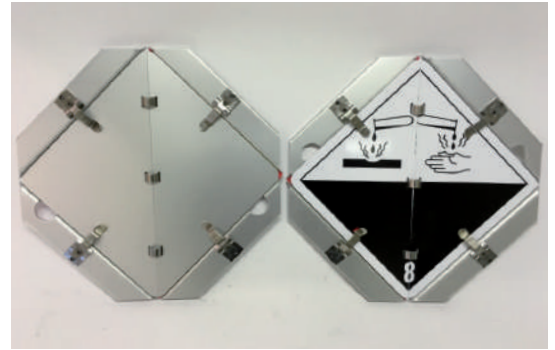
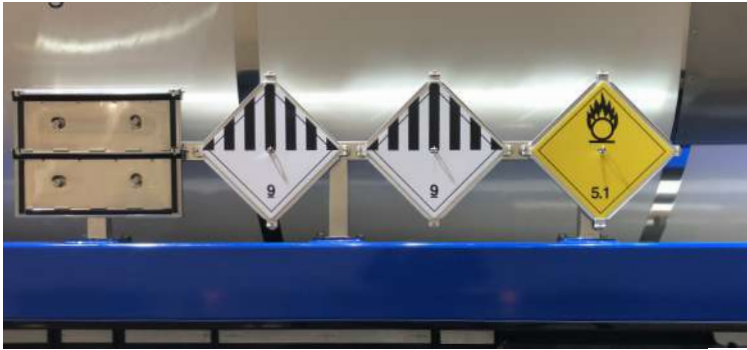

Art. Nr.	Kennzeichnung / Description	Abbildung / Sample
31.828.00	Wechselsystem mit 8 Zetteln & Neutralstand, Eloxiertes Aluminium (Grundplatte 2mm) Innenmaß System: 250x250mm Zettel. Mit 4 starken Klemmen zur Arretierung. Gewicht 1.3kg <i>Multilabel box hazardlabels 250x250x2mm anodized aluminum, with neutral position With 4 springlocks.</i>	
Inhalt/Content	0 Neutralstand 1 Klasse 3 2 Klasse 4.1 3 Klasse 5.1 4 Klasse 6.1 5 Klasse 8 6 Klasse 9 7 Kennzeichnung Umweltgefährdend (Fisch/Baum) 8 Kennzeichnung Thermometer	<i>Neutral Class 3 Class 4.1 Class 5.1 Class 6.1 Class 8 Class 9 EHS label (fish/tree) Thermometer</i>

**Gefahrgut Wechselsystem mit weniger Etiketten (nach Wahl) /
 Multilabelbox with less labels (as desired)**

31.826.00	Mit 6 Zetteln & Neutralstand - <i>With 6 labels & neutral</i>
31.825.00	Mit 5 Zetteln & Neutralstand - <i>With 5 labels & neutral</i>
31.824.00	Mit 4 Zetteln & Neutralstand - <i>With 4 labels & neutral</i>
31.823.00	Mit 3 Zetteln & Neutralstand - <i>With 3 labels & neutral</i>
31.822.00	Mit 2 Zetteln & Neutralstand - <i>With 2 labels & neutral</i>
31.821.00	Mit 1 Zettel & Neutralstand - <i>With 1 label & neutral</i>

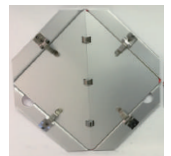

300x300mm Zettel selbstklebend / Label adhesive

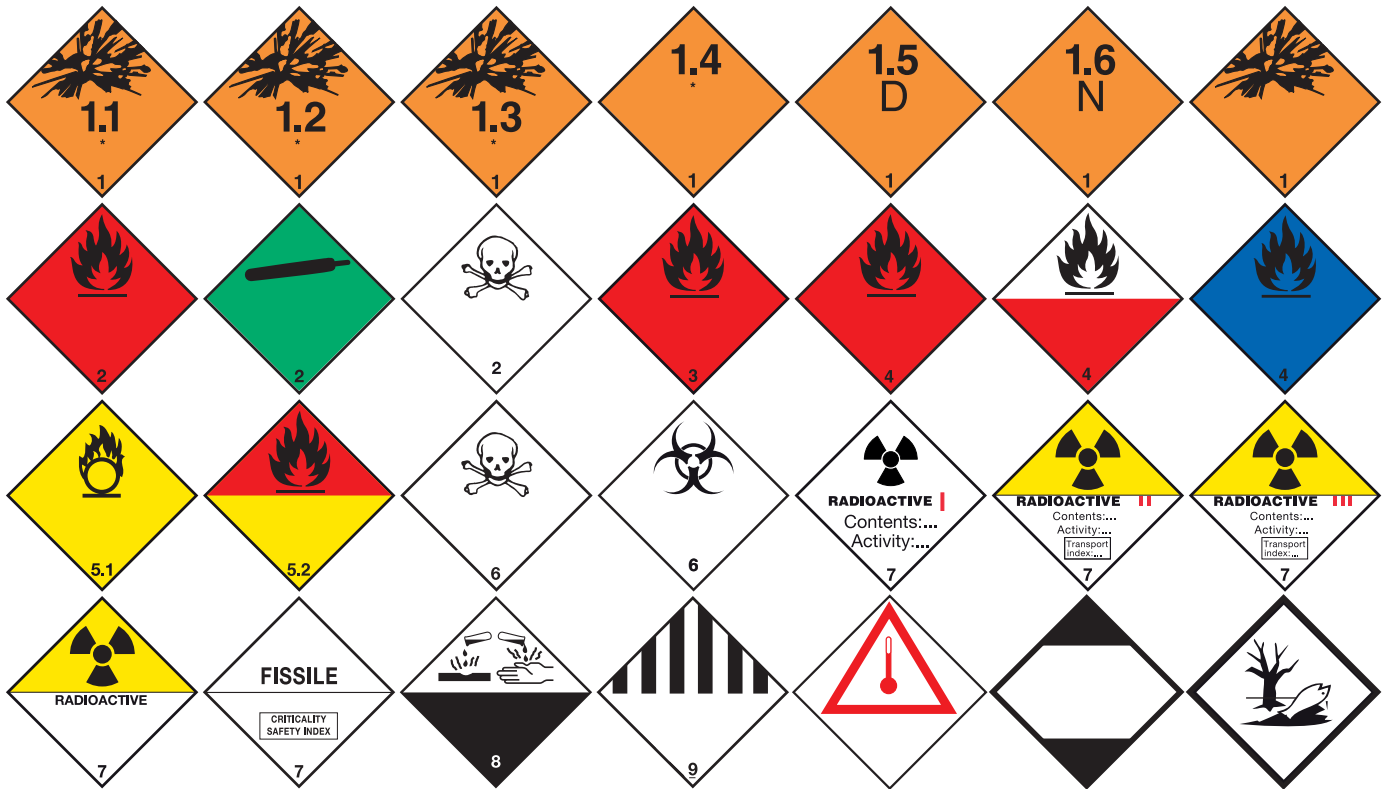

Art. Nr.

Zettel Klasse / Label Class

29.118.00	1.1
29.119.00	1.2
29.120.00	1.3
29.121.00	1.4
29.122.00	1.5
29.123.00	1.6
29.124.00	1 - Model 01
29.145.00	2.1
29.101.00	2.2
29.110.00	2.3
29.102.00	3
29.103.00	4.1
29.104.00	4.2
29.105.00	4.3
29.107.00	5.1
29.108.00	5.2
29.109.00	6.1
29.111.00	6.2
29.112.00	7A
29.113.00	7B
29.114.00	7C
29.115.00	7D
29.146.00	7E
29.116.00	8
29.117.00	9
29.125.00	Thermometer / Thermometer
29.128.00	EHS Umwelt / EHS environment
29.129.00	Limitierte Anzahl / Limited Quantity

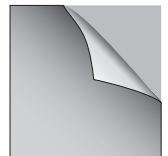

300x300mm
Aufkleber
Sticker

300x300x0,8mm Zettel Magnetisch / Label magnetic

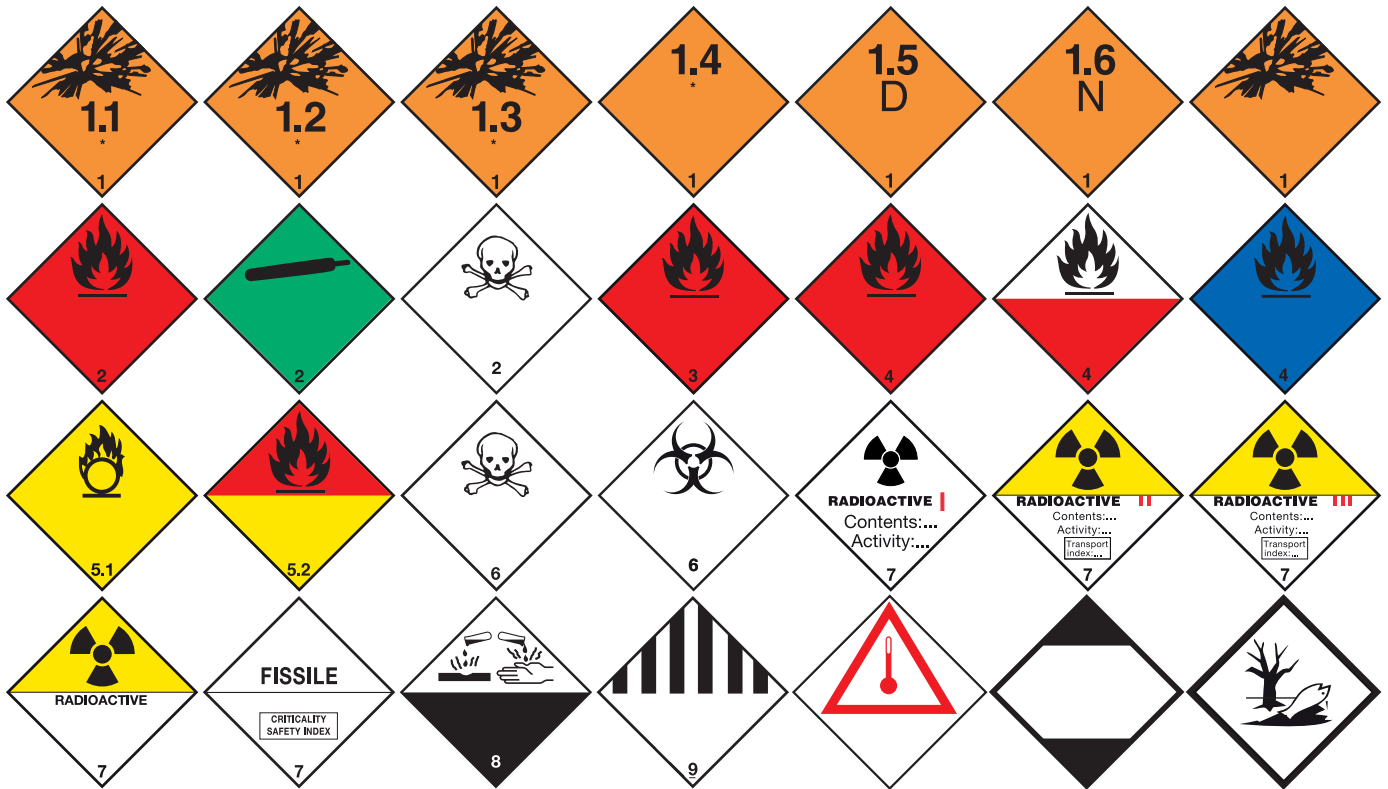

Art. Nr. + 27.920.00

Zettel Klasse / Label Class

29.118.00 + 27.920.00
 29.119.00 + 27.920.00
 29.120.00 + 27.920.00
 29.121.00 + 27.920.00
 29.122.00 + 27.920.00
 29.123.00 + 27.920.00
 29.124.00 + 27.920.00
 29.145.00 + 27.920.00
 29.101.00 + 27.920.00
 29.110.00 + 27.920.00
 29.102.00 + 27.920.00
 29.103.27
 29.104.00 + 27.920.00
 29.105.00 + 27.920.00
 29.107.00 + 27.920.00
 29.108.00 + 27.920.00
 29.109.00 + 27.920.00
 29.111.00 + 27.920.00
 29.112.00 + 27.920.00
 29.113.00 + 27.920.00
 29.114.00 + 27.920.00
 29.115.00 + 27.920.00
 29.146.00 + 27.920.00
 29.116.00 + 27.920.00
 29.117.00 + 27.920.00
 29.125.00 + 27.920.00
 29.128.00 + 27.920.00
 29.129.00 + 27.920.00

1.1
 1.2
 1.3
 1.4
 1.5
 1.6
 1 - Model 01
 2.1
 2.2
 2.3
 3
 4.1
 4.2
 4.3
 5.1
 5.2
 6.1
 6.2
 7A
 B
 7C
 7D
 7E
 8
 9
 Thermometer / Thermometer
 EHS Umwelt / EHS environment
 Limitierte Anzahl / Limited Quantity

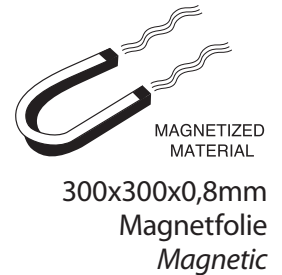

300x300x2mm Zettel Kunststoff / Label synthetic

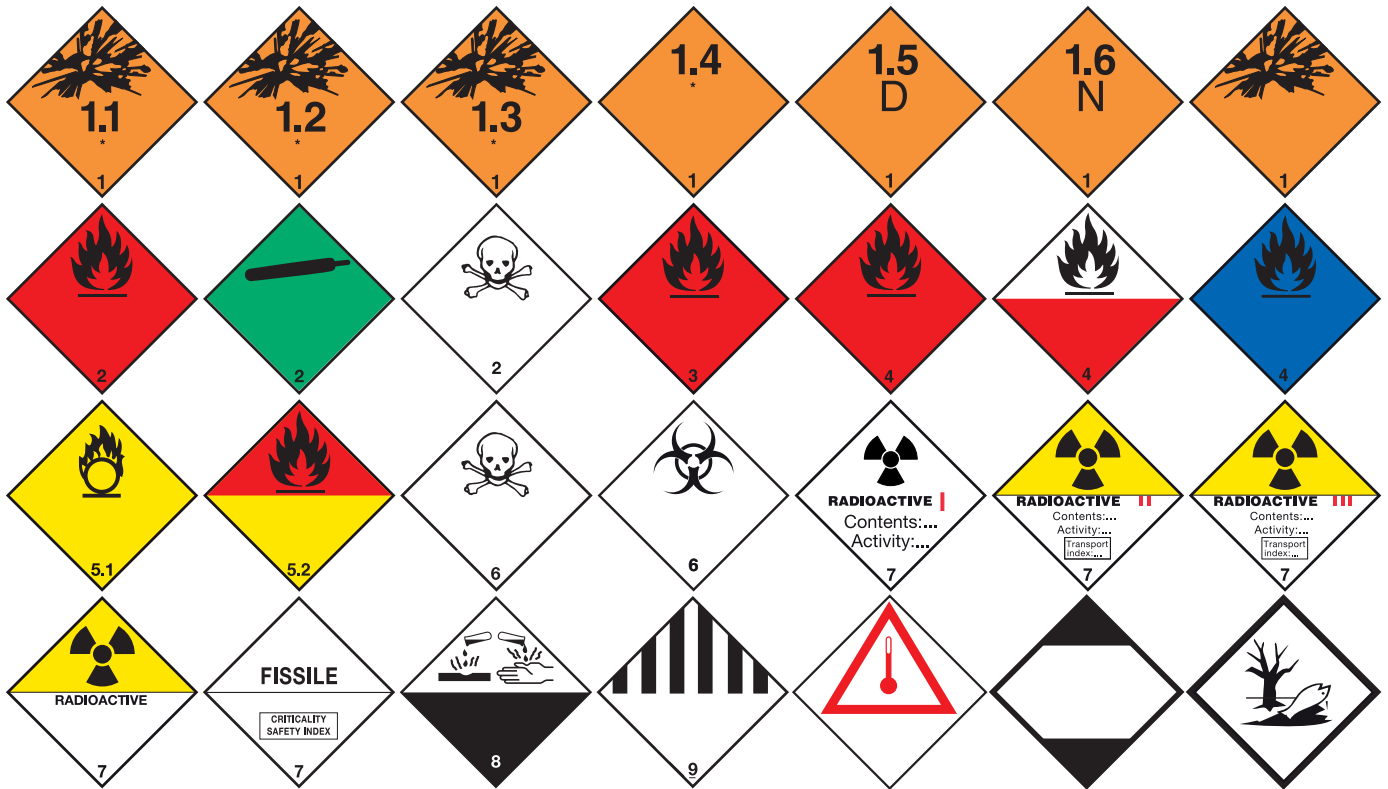

Art. Nr. + 26.920.00

Zettel Klasse / Label Class

29.118.00 + 26.920.00
 29.119.00 + 26.920.00
 29.120.00 + 26.920.00
 29.121.00 + 26.920.00
 29.122.00 + 26.920.00
 29.123.00 + 26.920.00
 29.124.00 + 26.920.00
 29.145.00 + 26.920.00
 29.101.00 + 26.920.00
 29.110.00 + 26.920.00
 29.102.00 + 26.920.00
 29.103.00 + 26.920.00
 29.104.00 + 26.920.00
 29.105.00 + 26.920.00
 29.107.00 + 26.920.00
 29.108.00 + 26.920.00
 29.109.00 + 26.920.00
 29.111.00 + 26.920.00
 29.112.00 + 26.920.00
 29.113.00 + 26.920.00
 29.114.00 + 26.920.00
 29.115.00 + 26.920.00
 29.146.00 + 26.920.00
 29.116.00 + 26.920.00
 29.117.00 + 26.920.00
 29.125.00 + 26.920.00
 29.128.00 + 26.920.00
 29.129.00 + 26.920.00

1.1
 1.2
 1.3
 1.4
 1.5
 1.6
 1 - Model 01
 2.1
 2.2
 2.3
 3
 4.1
 4.2
 4.3
 5.1
 5.2
 6.1
 6.2
 7A
 7B
 7C
 7D
 7E
 8
 9
 Thermometer / Thermometer
 EHS Umwelt / EHS environment
 Limitierte Anzahl / Limited Quantity

300x300x2mm
 Kunststoff (Forex)
 Synthetic (Forex)

300x300x1mm Zettel Stahlblech / Label zincplated steel

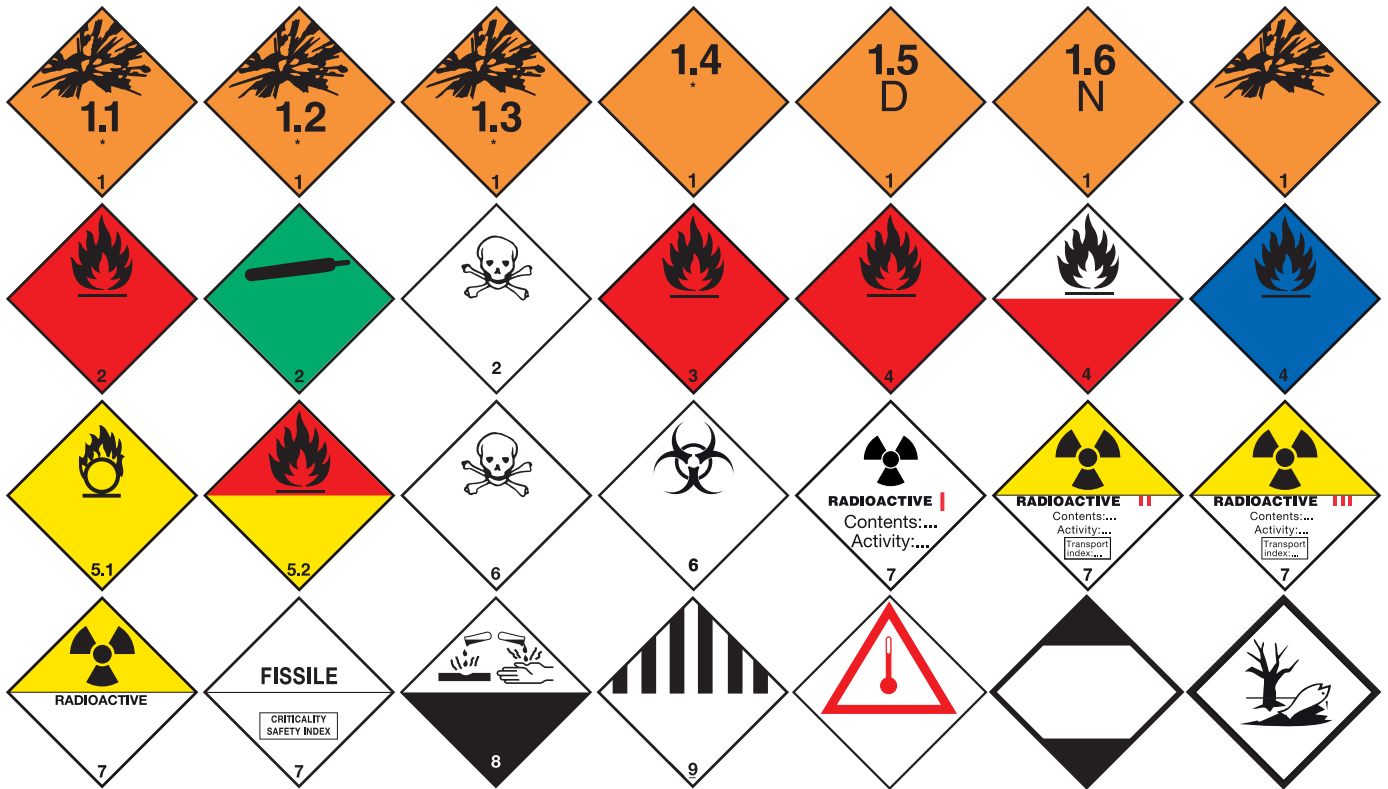

Art. Nr. + 33.920.00

Zettel Klasse / Label Class

29.118.00 + 33.920.00
 29.119.00 + 33.920.00
 29.120.00 + 33.920.00
 29.121.00 + 33.920.00
 29.122.00 + 33.920.00
 29.123.00 + 33.920.00
 29.124.00 + 33.920.00
 29.145.00 + 33.920.00
 29.101.00 + 33.920.00
 29.110.00 + 33.920.00
 29.102.00 + 33.920.00
 29.103.00 + 33.920.00
 29.104.00 + 33.920.00
 29.105.00 + 33.920.00
 29.107.00 + 33.920.00
 29.108.00 + 33.920.00
 29.109.00 + 33.920.00
 29.111.00 + 33.920.00
 29.112.00 + 33.920.00
 29.113.00 + 33.920.00
 29.114.00 + 33.920.00
 29.115.00 + 33.920.00
 29.146.00 + 33.920.00
 29.116.00 + 33.920.00
 29.117.00 + 33.920.00
 29.125.00 + 33.920.00
 29.128.00 + 33.920.00
 29.129.00 + 33.920.00

1.1
 1.2
 1.3
 1.4
 1.5
 1.6
 1 - Model 01
 2.1
 2.2
 2.3
 3
 4.1
 4.2
 4.3
 5.1
 5.2
 6.1
 6.2
 7A
 7B
 7C
 7D
 7E
 8
 9
 Thermometer / Thermometer
 EHS Umwelt / EHS environment
 Limitierte Anzahl / Limited Quantity

300x300x1mm
 Stahlblech
 Zincplated steel

300x300x1mm Zettel Aluminium / Label Aluminum

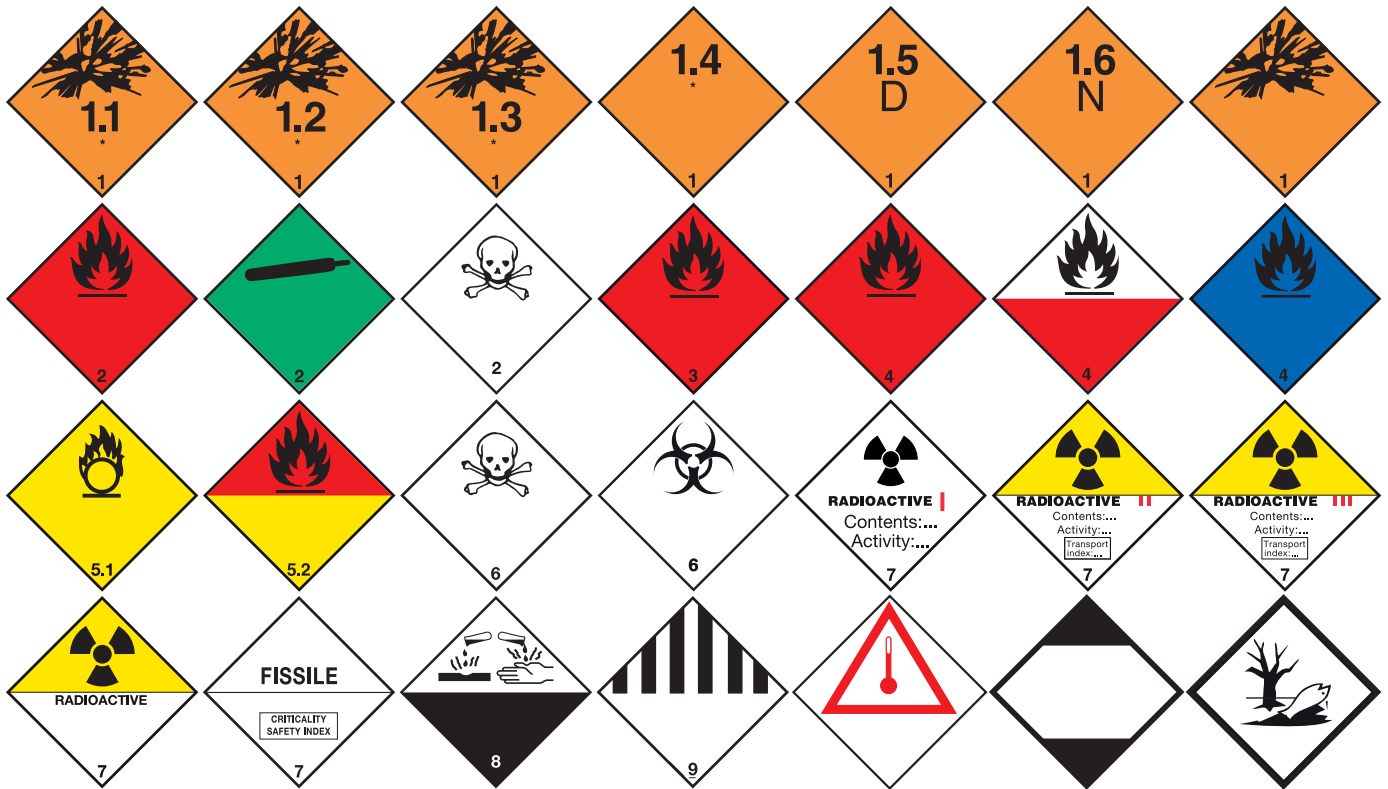

Art. Nr. + 31.920.00

Zettel Klasse / Label Class

29.118.00 + 31.920.00
 29.119.00 + 31.920.00
 29.120.00 + 31.920.00
 29.121.00 + 31.920.00
 29.122.00 + 31.920.00
 29.123.00 + 31.920.00
 29.124.00 + 31.920.00
 29.145.00 + 31.920.00
 29.101.00 + 31.920.00
 29.110.00 + 31.920.00
 29.102.00 + 31.920.00
 29.103.00 + 31.920.00
 29.104.00 + 31.920.00
 29.105.00 + 31.920.00
 29.107.00 + 31.920.00
 29.108.00 + 31.920.00
 29.109.00 + 31.920.00
 29.111.00 + 31.920.00
 29.112.00 + 31.920.00
 29.113.00 + 31.920.00
 29.114.00 + 31.920.00
 29.115.00 + 31.920.00
 29.146.00 + 31.920.00
 29.116.00 + 31.920.00
 29.117.00 + 31.920.00
 29.125.00 + 31.920.00
 29.128.00 + 31.920.00
 29.129.00 + 31.920.00

1.1
 1.2
 1.3
 1.4
 1.5
 1.6
 1 - Model 01
 2.1
 2.2
 2.3
 3
 4.1
 4.2
 4.3
 5.1
 5.2
 6.1
 6.2
 7A
 7B
 7C
 7D
 7E
 8
 9
 Thermometer / Thermometer
 EHS Umwelt / EHS environment
 Limitierte Anzahl / Limited Quantity

300x300x1mm
 Aluminium
 Aluminum

300x300x2mm Zettel Aluminium / Label Aluminum

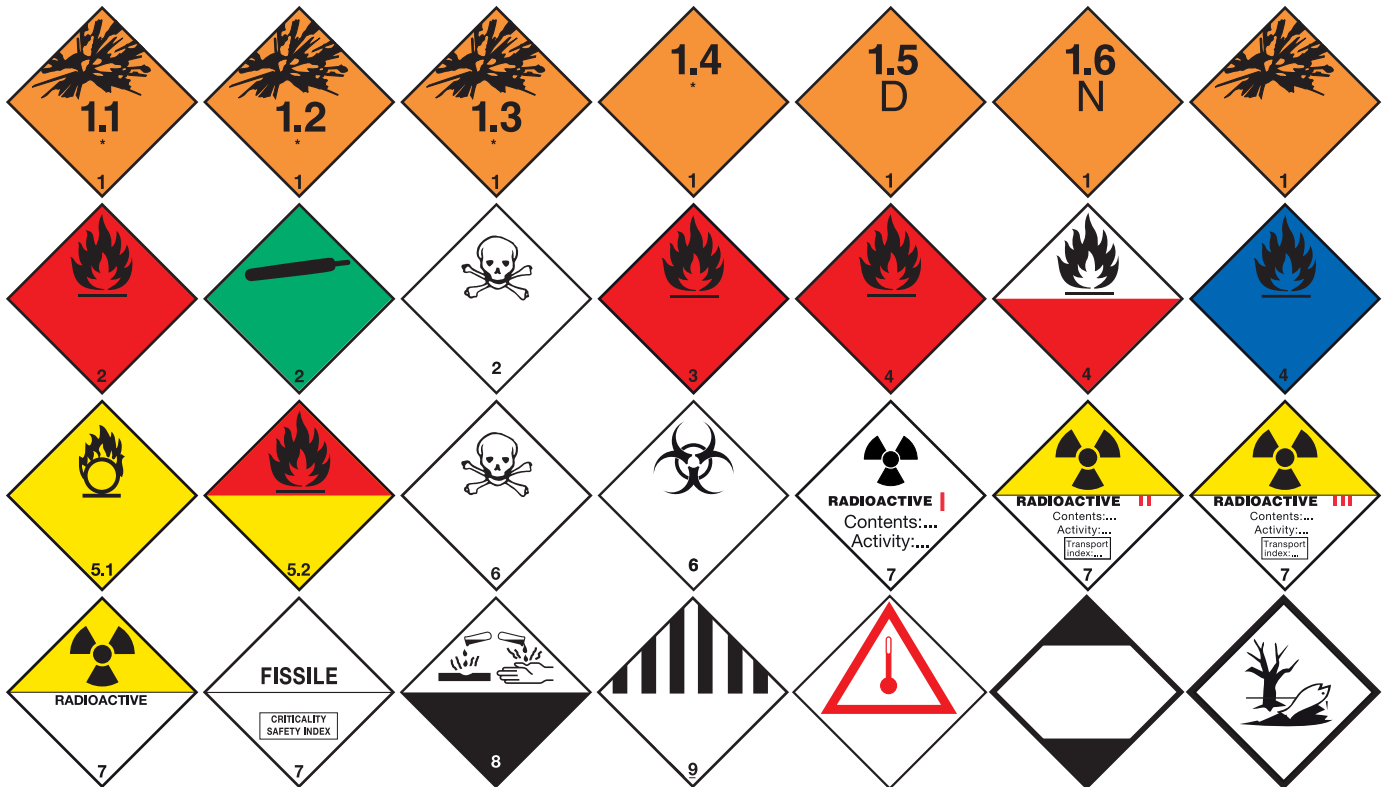

Art. Nr. + 32.920.00

Zettel Klasse / Label Class

29.118.00 + 32.920.00
 29.119.00 + 32.920.00
 29.120.00 + 32.920.00
 29.121.00 + 32.920.00
 29.122.00 + 32.920.00
 29.123.00 + 32.920.00
 29.124.00 + 32.920.00
 29.145.00 + 32.920.00
 29.101.00 + 32.920.00
 29.110.00 + 32.920.00
 29.102.00 + 32.920.00
 29.103.00 + 32.920.00
 29.104.00 + 32.920.00
 29.105.00 + 32.920.00
 29.107.00 + 32.920.00
 29.108.00 + 32.920.00
 29.109.00 + 32.920.00
 29.111.00 + 32.920.00
 29.112.00 + 32.920.00
 29.113.00 + 32.920.00
 29.114.00 + 32.920.00
 29.115.00 + 32.920.00
 29.146.00 + 32.920.00
 29.116.00 + 32.920.00
 29.117.00 + 32.920.00
 29.125.00 + 32.920.00
 29.128.00 + 32.920.00
 29.129.00 + 32.920.00

1.1
 1.2
 1.3
 1.4
 1.5
 1.6
 1 - Model 01
 2.1
 2.2
 2.3
 3
 4.1
 4.2
 4.3
 5.1
 5.2
 6.1
 6.2
 7A
 7B
 7C
 7D
 7E
 8
 9
 Thermometer / Thermometer
 EHS Umwelt / EHS environment
 Limitierte Anzahl / Limited Quantity

300x300x2mm
 Aluminium
 Aluminum

300x300x0,8mm Zettel Edelstahl / Label stainless steel

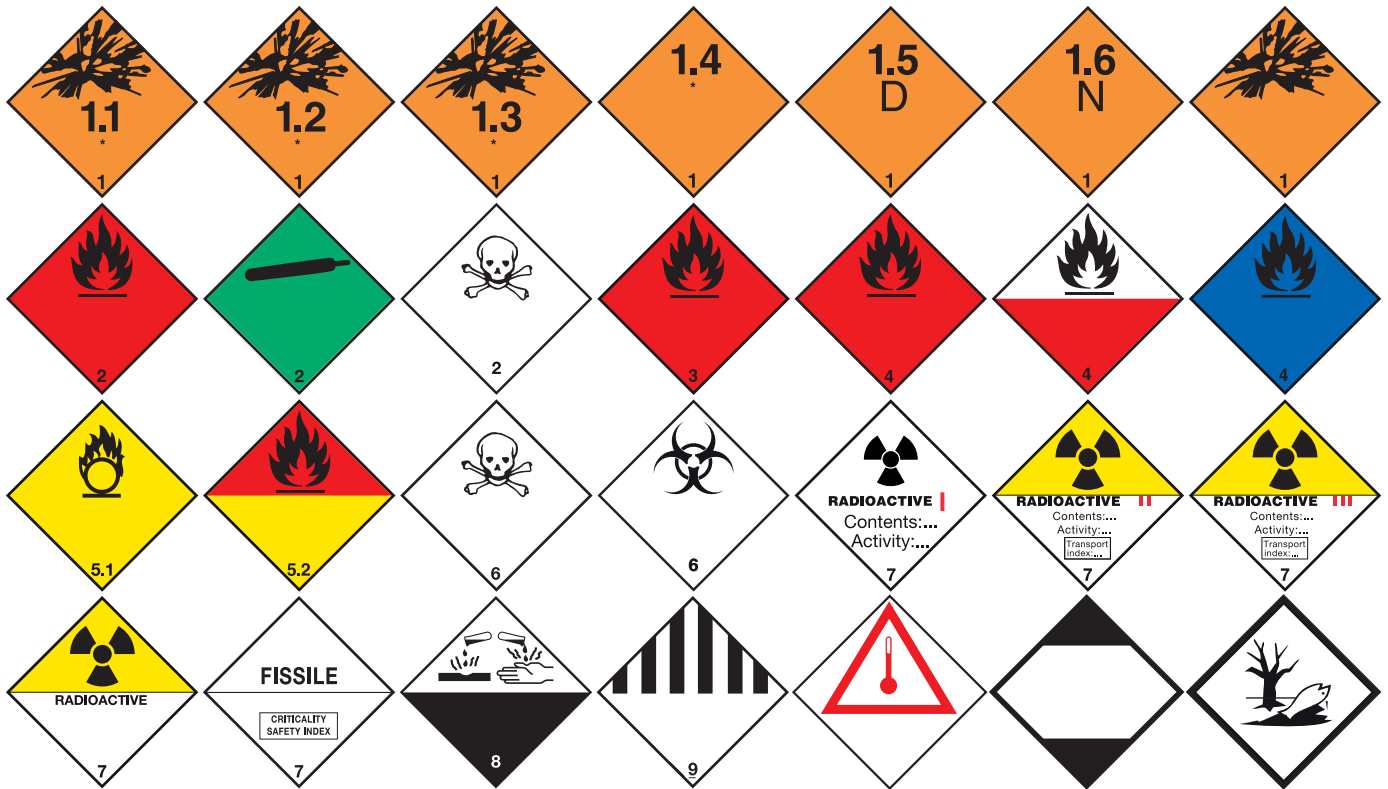

Art. Nr. + 35.920.00

Zettel Klasse / Label Class

29.118.00 + 35.920.00
 29.119.00 + 35.920.00
 29.120.00 + 35.920.00
 29.121.00 + 35.920.00
 29.122.00 + 35.920.00
 29.123.00 + 35.920.00
 29.124.00 + 35.920.00
 29.145.00 + 35.920.00
 29.101.00 + 35.920.00
 29.110.00 + 35.920.00
 29.102.00 + 35.920.00
 29.103.00 + 35.920.00
 29.104.00 + 35.920.00
 29.105.00 + 35.920.00
 29.107.00 + 35.920.00
 29.108.00 + 35.920.00
 29.109.00 + 35.920.00
 29.111.00 + 35.920.00
 29.112.00 + 35.920.00
 29.113.00 + 35.920.00
 29.114.00 + 35.920.00
 29.115.00 + 35.920.00
 29.146.00 + 35.920.00
 29.116.00 + 35.920.00
 29.117.00 + 35.920.00
 29.125.00 + 35.920.00
 29.128.00 + 35.920.00
 29.129.00 + 35.920.00

1.1
 1.2
 1.3
 1.4
 1.5
 1.6
 1 - Model 01
 2.1
 2.2
 2.3
 3
 4.1
 4.2
 4.3
 5.1
 5.2
 6.1
 6.2
 7A
 7B
 7C
 7D
 7E
 8
 9
 Thermometer / Thermometer
 EHS Umwelt / EHS environment
 Limitierte Anzahl / Limited Quantity

300x300x0,8mm
 Edelstahl
 Stainless steel

300x300x1mm Zettel Aluminium Klappbar / Label Aluminum foldable

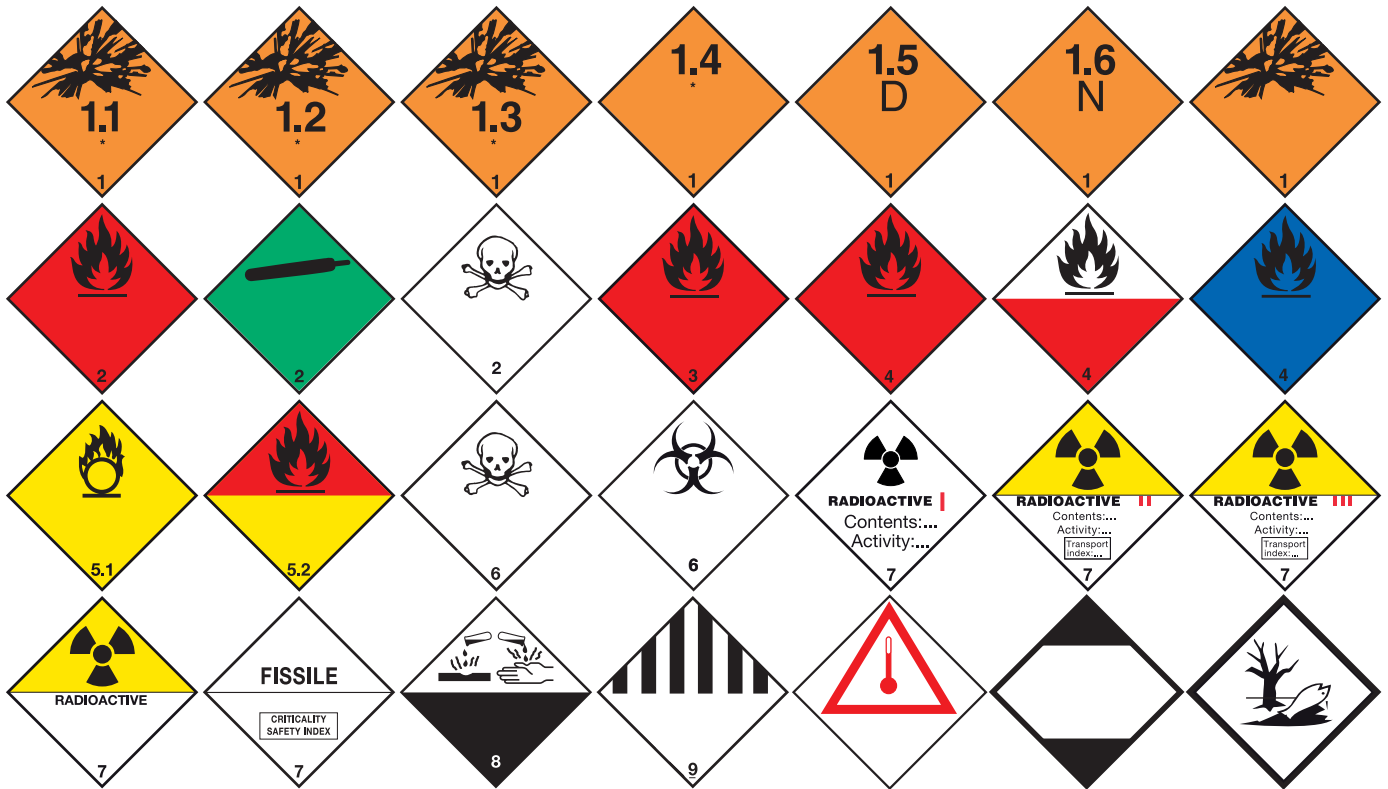

Art. Nr. + 31.922.00

Zettel Klasse / Label Class

29.118.00 + 31.922.00
 29.119.00 + 31.922.00
 29.120.00 + 31.922.00
 29.121.00 + 31.922.00
 29.122.00 + 31.922.00
 29.123.00 + 31.922.00
 29.124.00 + 31.922.00
 29.145.00 + 31.922.00
 29.101.00 + 31.922.00
 29.110.00 + 31.922.00
 29.102.00 + 31.922.00
 29.103.00 + 31.922.00
 29.104.00 + 31.922.00
 29.105.00 + 31.922.00
 29.107.00 + 31.922.00
 29.108.00 + 31.922.00
 29.109.00 + 31.922.00
 29.111.00 + 31.922.00
 29.112.00 + 31.922.00
 29.113.00 + 31.922.00
 29.114.00 + 31.922.00
 29.115.00 + 31.922.00
 29.146.00 + 31.922.00
 29.116.00 + 31.922.00
 29.117.00 + 31.922.00
 29.125.00 + 31.922.00
 29.128.00 + 31.922.00
 29.129.00 + 31.922.00

1.1
 1.2
 1.3
 1.4
 1.5
 1.6
 1 - Model 01
 2.1
 2.2
 2.3
 3
 4.1
 4.2
 4.3
 5.1
 5.2
 6.1
 6.2
 7A
 7B
 7C
 7D
 7E
 8
 9
 Thermometer / Thermometer
 EHS Umwelt / EHS environment
 Limitierte Anzahl / Limited Quantity

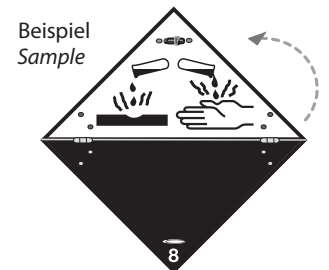

300x300x1mm
 Aluminium
 Aluminum

250x250mm Zettel selbstklebend / Label adhesive

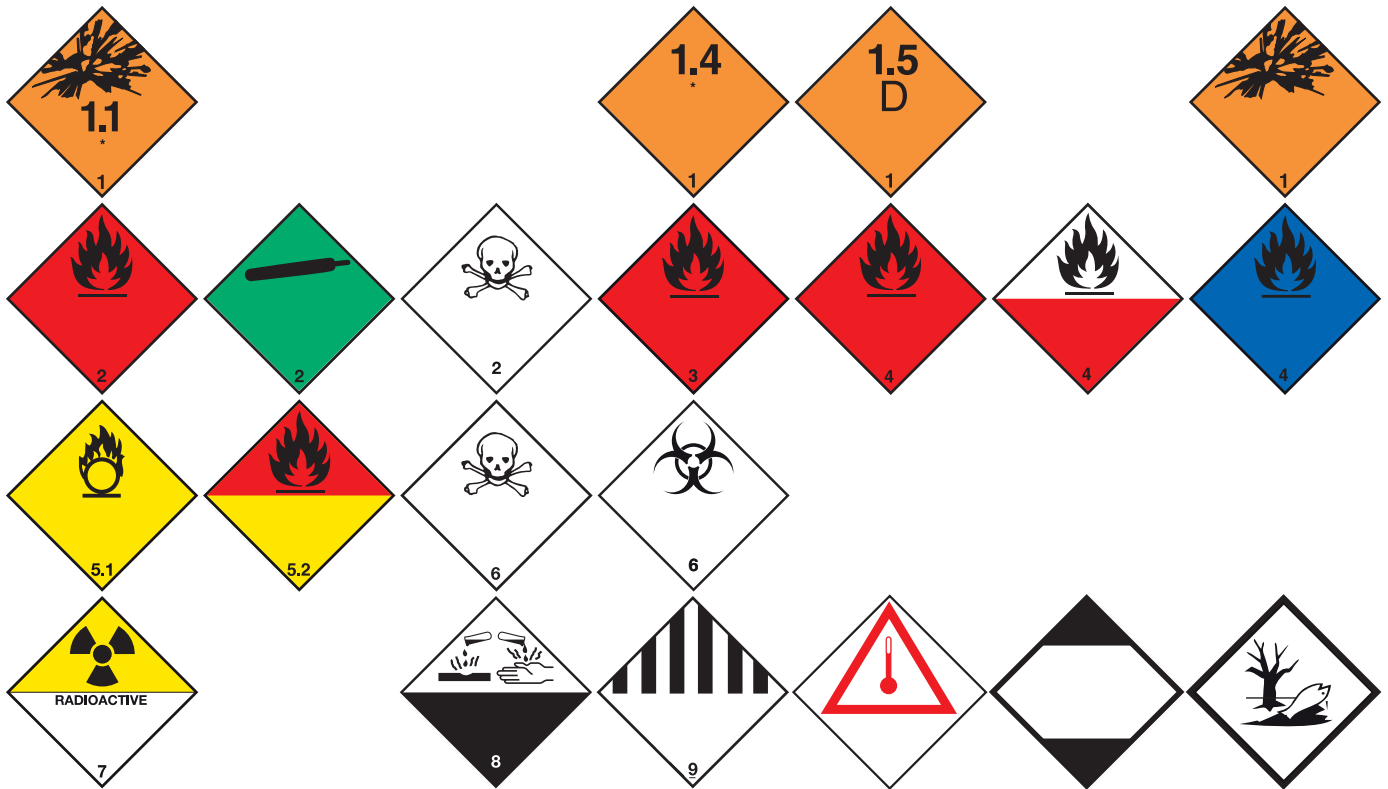

Art. Nr.

Zettel Klasse / Label Class

29.618.00	1.1
29.618.00B	1.1.B
29.618.00D	1.1.D
29.621.00	1.4
29.622.00	1.5
29.624.00	1 - Model 01
29.645.00	2.1
29.601.00	2.2
29.610.00	2.3
29.602.00	3
29.603.00	4.1
29.604.00	4.2
29.605.00	4.3
29.607.00	5.1
29.608.00	5.2
29.609.00	6.1
29.611.00	6.2
29.615.00	7D
29.616.00	8
29.617.00	9
29.625.00	Thermometer / Thermometer
29.628.00	EHS Umwelt / EHS environment
29.629.00	Limitierte Anzahl / Limited Quantity

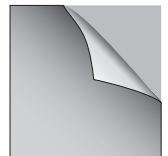
250x250mm
Aufkleber
Sticker

250x250x0,8mm Zettel Magnetisch / Label magnetic

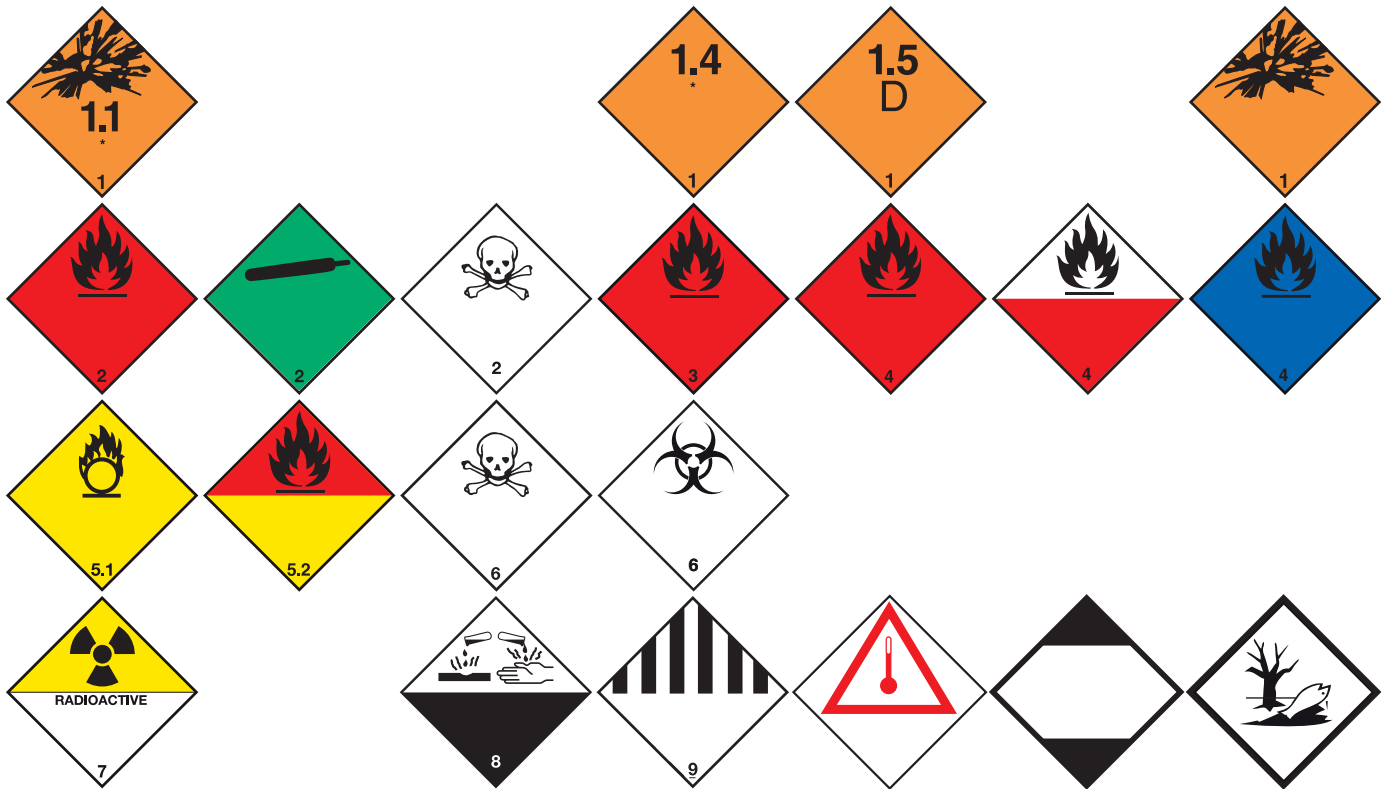

Art. Nr. + 27.926.00

Zettel Klasse / Label Class

29.618.00 + 27.926.00
 29.618.00B + 27.926.00
 29.618.00D + 27.926.00
 29.621.00 + 27.926.00
 29.622.00 + 27.926.00
 29.624.00 + 27.926.00
 29.645.00 + 27.926.00
 29.601.00 + 27.926.00
 29.610.00 + 27.926.00
 29.602.00 + 27.926.00
 29.603.00 + 27.926.00
 29.604.00 + 27.926.00
 29.605.00 + 27.926.00
 29.607.00 + 27.926.00
 29.608.00 + 27.926.00
 29.609.00 + 27.926.00
 29.611.00 + 27.926.00
 29.615.00 + 27.926.00
 29.616.00 + 27.926.00
 29.617.00 + 27.926.00
 29.625.00 + 27.926.00
 29.628.00 + 27.926.00
 29.629.00 + 27.926.00

1.1
 1.1.B
 1.1.D
 1.4
 1.5
 1 - Model 01
 2.1
 2.2
 2.3
 3
 4.1
 4.2
 4.3
 5.1
 5.2
 6.1
 6.2
 7D
 8
 9
 Thermometer / Thermometer
 EHS Umwelt / EHS environment
 Limitierte Anzahl / Limited Quantity

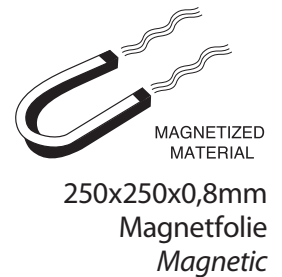

250x250x2mm Zettel Kunststoff / Label synthetic

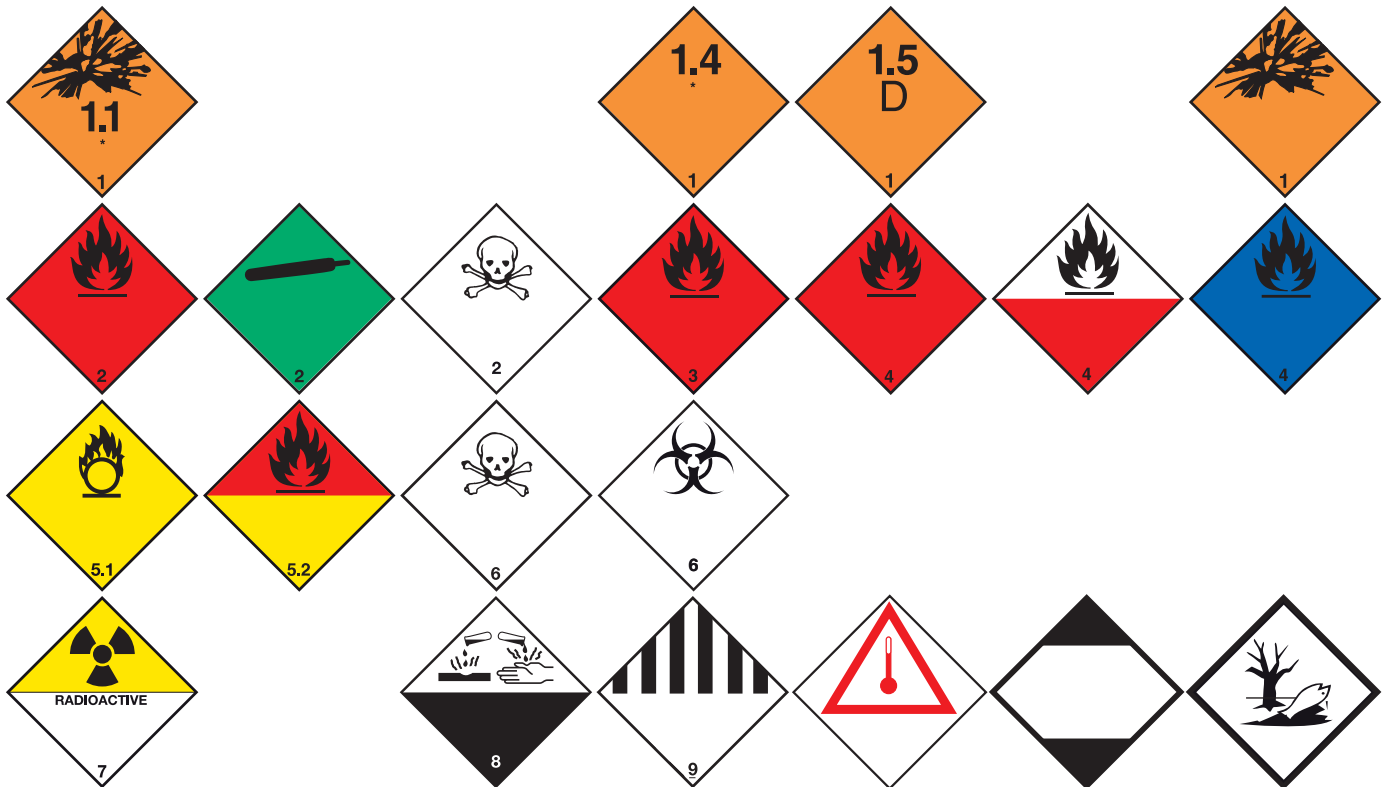

Art. Nr. + 26.926.00

Zettel Klasse / Label Class

29.618.00 + 26.926.00
 29.618.00B + 26.926.00
 29.618.00D + 26.926.00
 29.621.00 + 26.926.00
 29.622.00 + 26.926.00
 29.624.00 + 26.926.00
 29.645.00 + 26.926.00
 29.601.00 + 26.926.00
 29.610.00 + 26.926.00
 29.602.00 + 26.926.00
 29.603.00 + 26.926.00
 29.604.00 + 26.926.00
 29.605.00 + 26.926.00
 29.607.00 + 26.926.00
 29.608.00 + 26.926.00
 29.609.00 + 26.926.00
 29.611.00 + 26.926.00
 29.615.00 + 26.926.00
 29.616.00 + 26.926.00
 29.617.00 + 26.926.00
 29.625.00 + 26.926.00
 29.628.00 + 26.926.00
 29.629.00 + 26.926.00

1.1
 1.1.B
 1.1.D
 1.4
 1.5
 1 - Model 01
 2.1
 2.2
 2.3
 3
 4.1
 4.2
 4.3
 5.1
 5.2
 6.1
 6.2
 7D
 8
 9
 Thermometer / Thermometer
 EHS Umwelt / EHS environment
 Limitierte Anzahl / Limited Quantity

250x250x2mm
 Kunststoff (Forex)
 Synthetic (Forex)

250x250x1mm Zettel Stahlblech / Label zincplated steel

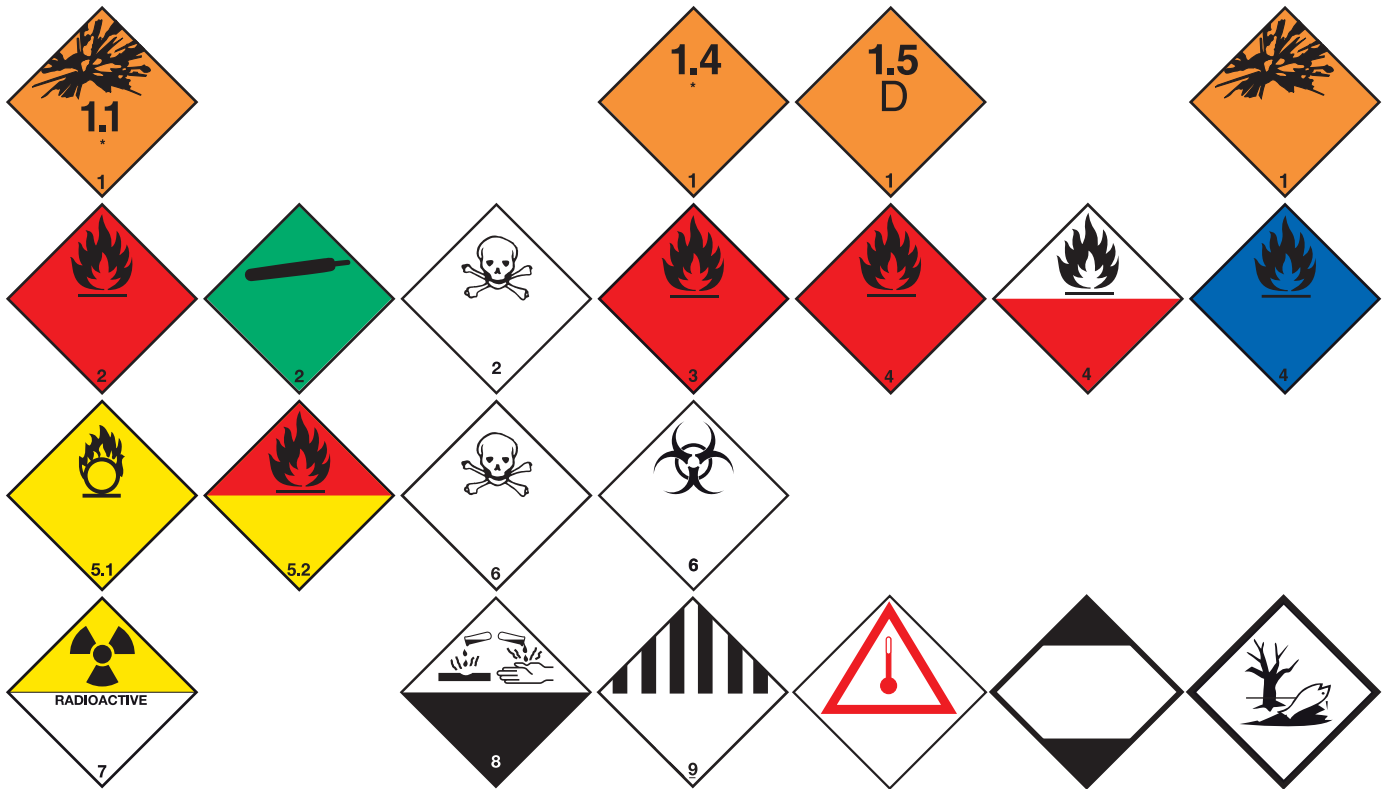

Art. Nr. + 33.926.00

Zettel Klasse / Label Class

29.618.00 + 33.926.00
 29.618.00B + 33.926.00
 29.618.00D + 33.926.00
 29.621.00 + 33.926.00
 29.622.00 + 33.926.00
 29.624.00 + 33.926.00
 29.645.00 + 33.926.00
 29.601.00 + 33.926.00
 29.610.00 + 33.926.00
 29.602.00 + 33.926.00
 29.603.00 + 33.926.00
 29.604.00 + 33.926.00
 29.605.00 + 33.926.00
 29.607.00 + 33.926.00
 29.608.00 + 33.926.00
 29.609.00 + 33.926.00
 29.611.00 + 33.926.00
 29.615.00 + 33.926.00
 29.616.00 + 33.926.00
 29.617.00 + 33.926.00
 29.625.00 + 33.926.00
 29.628.00 + 33.926.00
 29.629.00 + 33.926.00

1.1
 1.1.B
 1.1.D
 1.4
 1.5
 1 - Model 01
 2.1
 2.2
 2.3
 3
 4.1
 4.2
 4.3
 5.1
 5.2
 6.1
 6.2
 7D
 8
 9
 Thermometer / Thermometer
 EHS Umwelt / EHS environment
 Limitierte Anzahl / Limited Quantity

250x250x1mm
 Stahlblech
 Zincplated steel

250x250x1mm Zettel Aluminium / Label Aluminum

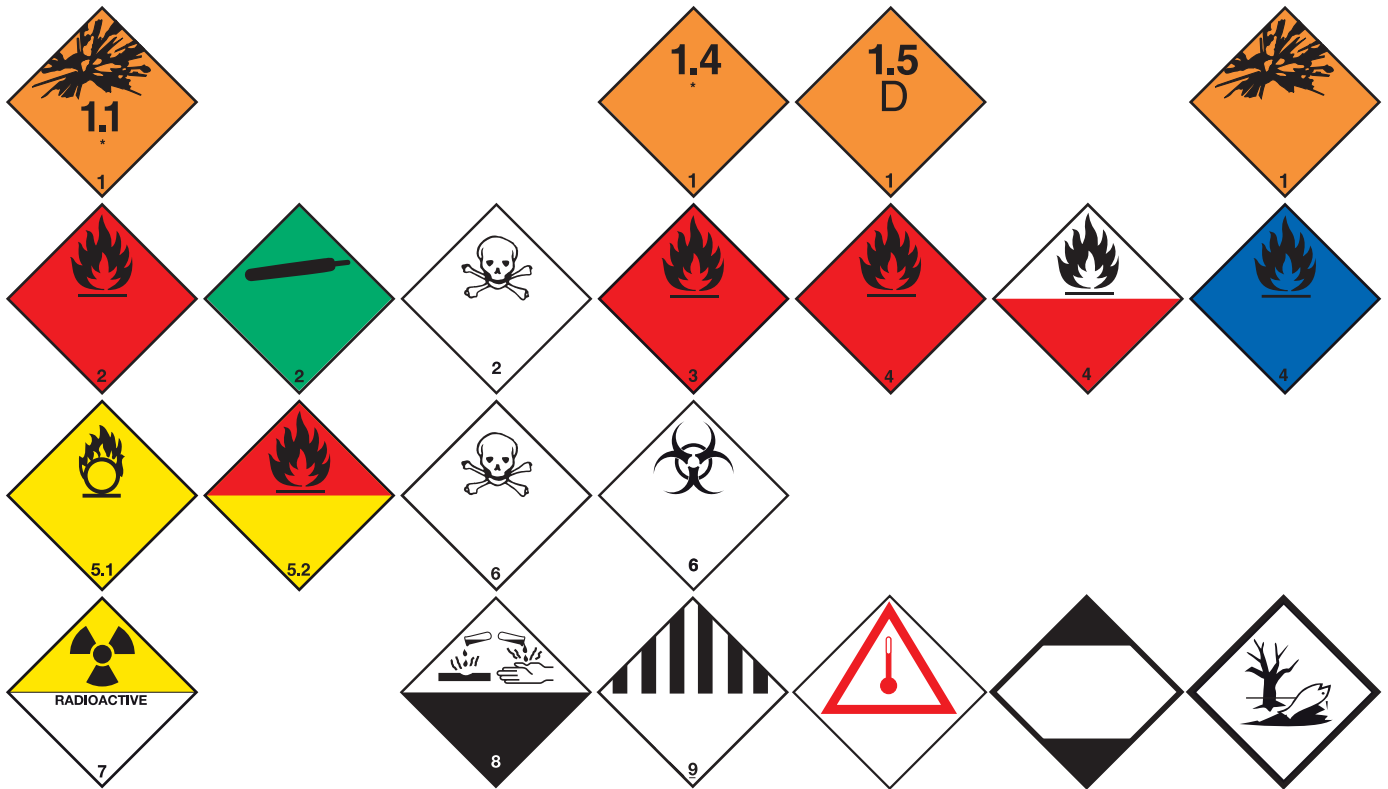

Art. Nr. + 31.926.00

Zettel Klasse / Label Class

29.618.00 + 31.926.00
 29.618.00B + 31.926.00
 29.618.00D + 31.926.00
 29.621.00 + 31.926.00
 29.622.00 + 31.926.00
 29.624.00 + 31.926.00
 29.645.00 + 31.926.00
 29.601.00 + 31.926.00
 29.610.00 + 31.926.00
 29.602.00 + 31.926.00
 29.603.00 + 31.926.00
 29.604.00 + 31.926.00
 29.605.00 + 31.926.00
 29.607.00 + 31.926.00
 29.608.00 + 31.926.00
 29.609.00 + 31.926.00
 29.611.00 + 31.926.00
 29.615.00 + 31.926.00
 29.616.00 + 31.926.00
 29.617.00 + 31.926.00
 29.625.00 + 31.926.00
 29.628.00 + 31.926.00
 29.629.00 + 31.926.00

1.1
 1.1.B
 1.1.D
 1.4
 1.5
 1 - Model 01
 2.1
 2.2
 2.3
 3
 4.1
 4.2
 4.3
 5.1
 5.2
 6.1
 6.2
 7D
 8
 9
 Thermometer / Thermometer
 EHS Umwelt / EHS environment
 Limitierte Anzahl / Limited Quantity

250x250x1mm
 Aluminium
 Aluminum

250x250x2mm Zettel Aluminium / Label Aluminum

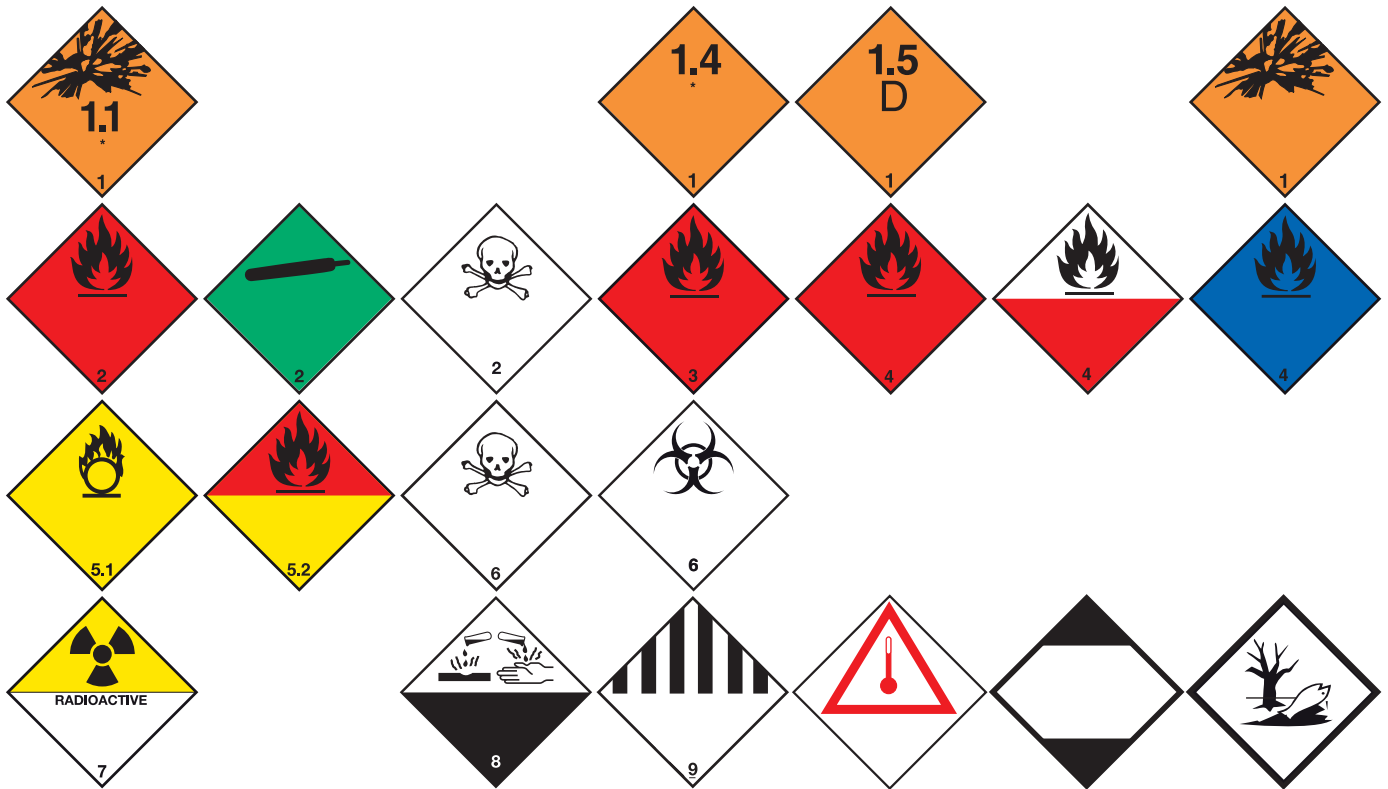

Art. Nr. + 32.926.00

Zettel Klasse / Label Class

29.618.00 + 32.926.00
 29.618.00B + 32.926.00
 29.618.00D + 32.926.00
 29.621.00 + 32.926.00
 29.622.00 + 32.926.00
 29.624.00 + 32.926.00
 29.645.00 + 32.926.00
 29.601.00 + 32.926.00
 29.610.00 + 32.926.00
 29.602.00 + 32.926.00
 29.603.00 + 32.926.00
 29.604.00 + 32.926.00
 29.605.00 + 32.926.00
 29.607.00 + 32.926.00
 29.608.00 + 32.926.00
 29.609.00 + 32.926.00
 29.611.00 + 32.926.00
 29.615.00 + 32.926.00
 29.616.00 + 32.926.00
 29.617.00 + 32.926.00
 29.625.00 + 32.926.00
 29.628.00 + 32.926.00
 29.629.00 + 32.926.00

1.1
 1.1.B
 1.1.D
 1.4
 1.5
 1 - Model 01
 2.1
 2.2
 2.3
 3
 4.1
 4.2
 4.3
 5.1
 5.2
 6.1
 6.2
 7D
 8
 9
 Thermometer / Thermometer
 EHS Umwelt / EHS environment
 Limitierte Anzahl / Limited Quantity

250x250x2mm
 Aluminium
 Aluminum

250x250x0,8mm Zettel Edelstahl / Label stainless steel

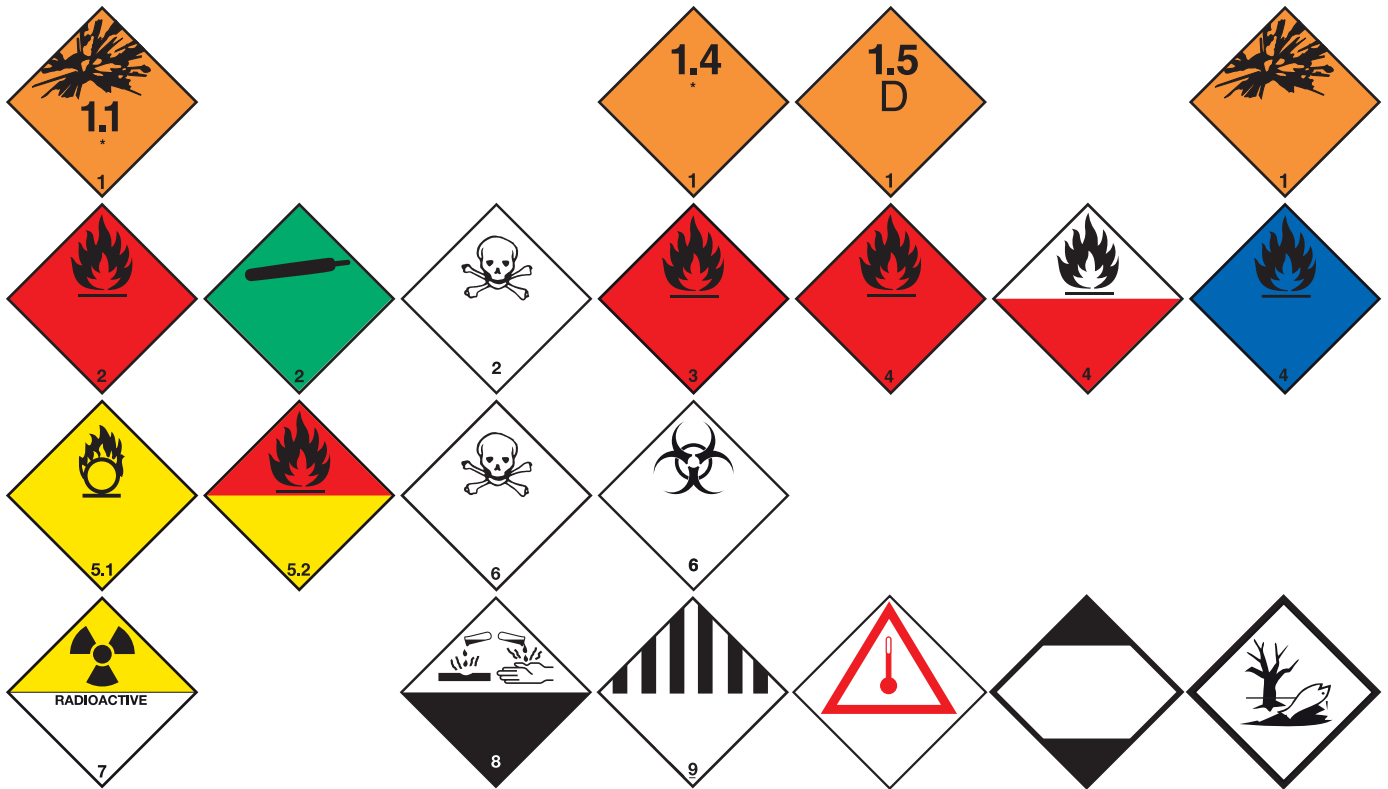

Art. Nr. + 35.926.00

Zettel Klasse / Label Class

29.618.00 + 35.926.00
 29.618.00B + 35.926.00
 29.618.00D + 35.926.00
 29.621.00 + 35.926.00
 29.622.00 + 35.926.00
 29.624.00 + 35.926.00
 29.645.00 + 35.926.00
 29.601.00 + 35.926.00
 29.610.00 + 35.926.00
 29.602.00 + 35.926.00
 29.603.00 + 35.926.00
 29.604.00 + 35.926.00
 29.605.00 + 35.926.00
 29.607.00 + 35.926.00
 29.608.00 + 35.926.00
 29.609.00 + 35.926.00
 29.611.00 + 35.926.00
 29.615.00 + 35.926.00
 29.616.00 + 35.926.00
 29.617.00 + 35.926.00
 29.625.00 + 35.926.00
 29.628.00 + 35.926.00
 29.629.00 + 35.926.00

1.1
 1.1.B
 1.1.D
 1.4
 1.5
 1 - Model 01
 2.1
 2.2
 2.3
 3
 4.1
 4.2
 4.3
 5.1
 5.2
 6.1
 6.2
 7D
 8
 9
 Thermometer / Thermometer
 EHS Umwelt / EHS environment
 Limitierte Anzahl / Limited Quantity

250x250x0,8mm
 Edelstahl
 Stainless steel

250x250x1mm Zettel Aluminium Klappbar / Label Aluminum foldable

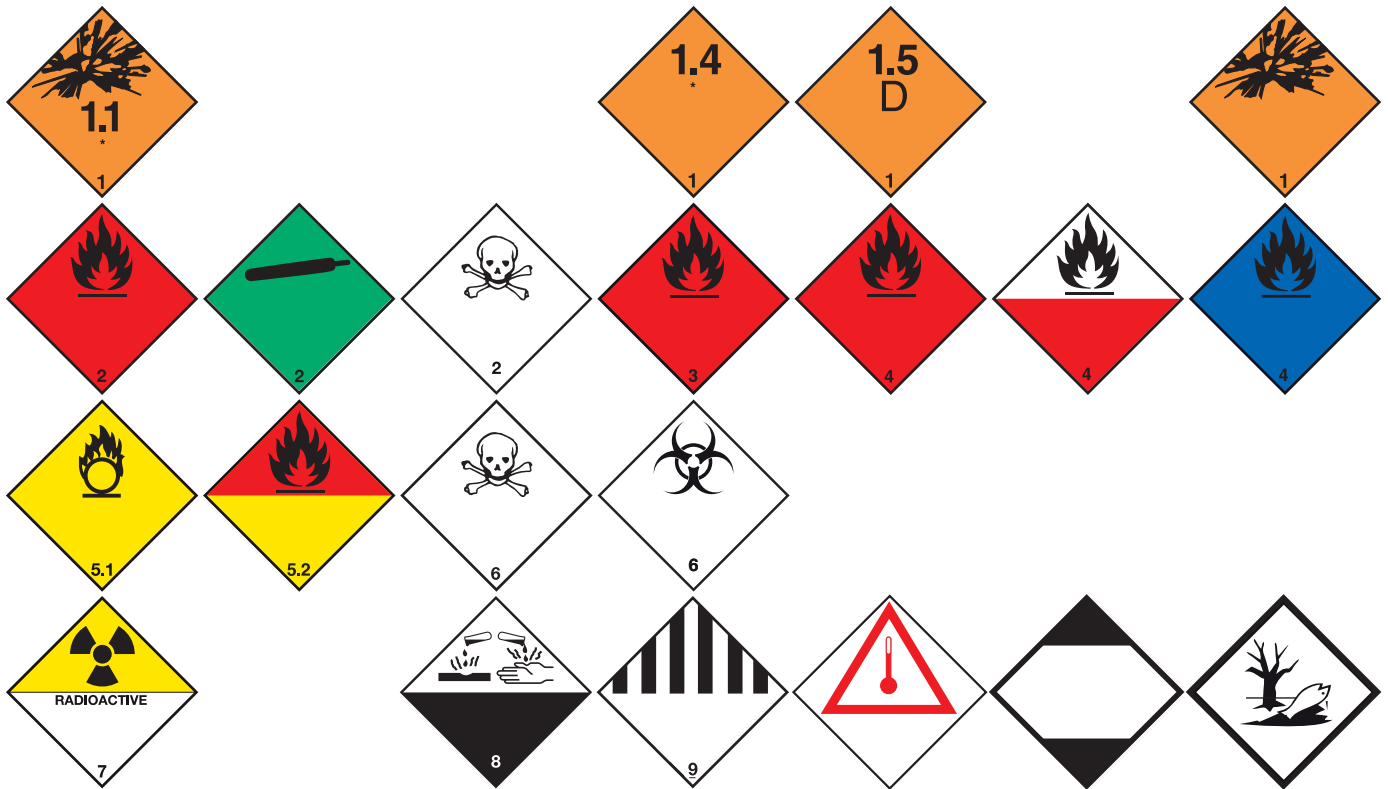

Art. Nr. + 31.924.00

Zettel Klasse / Label Class

29.618.00 + 31.924.00
 29.618.00B + 31.924.00
 29.618.00D + 31.924.00
 29.621.00 + 31.924.00
 29.622.00 + 31.924.00
 29.624.00 + 31.924.00
 29.645.00 + 31.924.00
 29.601.00 + 31.924.00
 29.610.00 + 31.924.00
 29.602.00 + 31.924.00
 29.603.00 + 31.924.00
 29.604.00 + 31.924.00
 29.605.00 + 31.924.00
 29.607.00 + 31.924.00
 29.608.00 + 31.924.00
 29.609.00 + 31.924.00
 29.611.00 + 31.924.00
 29.615.00 + 31.924.00
 29.616.00 + 31.924.00
 29.617.00 + 31.924.00
 29.625.00 + 31.924.00
 29.628.00 + 31.924.00
 29.629.00 + 31.924.00

1.1
 1.1.B
 1.1.D
 1.4
 1.5
 1 - Model 01
 2.1
 2.2
 2.3
 3
 4.1
 4.2
 4.3
 5.1
 5.2
 6.1
 6.2
 7D
 8
 9
 Thermometer / Thermometer
 EHS Umwelt / EHS environment
 Limitierte Anzahl / Limited Quantity

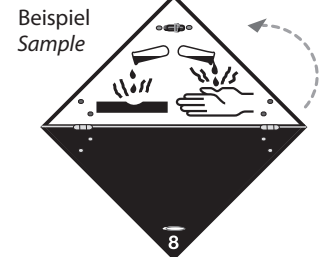

250x250x1mm
 Aluminium
 Aluminum

100x100mm Verpackungszettel selbstklebend / Packaginglabel adhesive

ADR Klein-Zettel / ADR hazard label

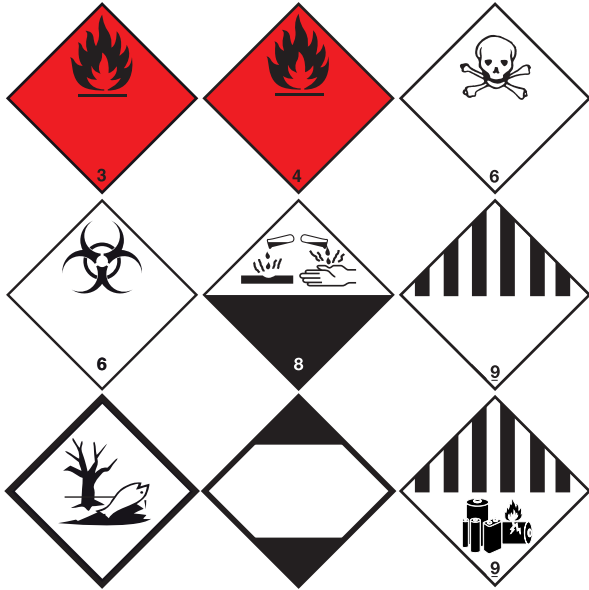

IMO Klein-Zettel / IMO hazard label

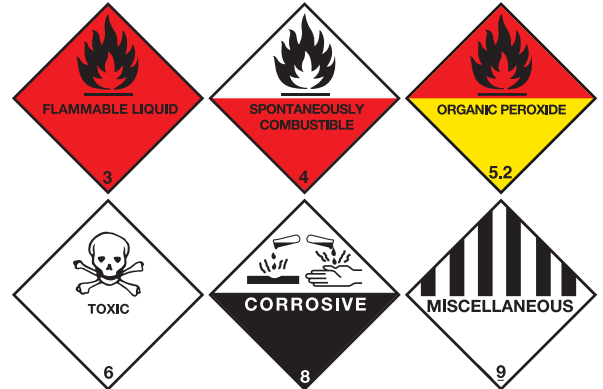

Art. Nr.

Zettel Klasse / Label Class

29.302.00	3	
29.302.IMO	3 FLAMMABLE LIQUID	
29.303.00	4.1	
29.304.00	4.2	
29.304.IMO	4.2 SPONTANEOUSLY COMBUSTABLE	
29.309.00	6.1	
29.309.IMO	6.1 TOXIC	
29.311.00	6.2	
29.316.00	8	
29.316.IMO	8 CORROSIVE	
29.317.00	9	(ADR=IMO)
29.328.00	EHS Umwelt / EHS environment	(ADR=IMO)
29.329.00	Limited Quantity	(ADR=IMO)
29.330.00	Vorsicht / Handle with care	(Orange)
29.337.00	9A	(Batteries)



100x100mm
Aufkleber
Sticker

250x250mm Verpackungszettel selbstklebend / Packaginglabel adhesive



Art. Nr.

Zettel Klasse / Label Class

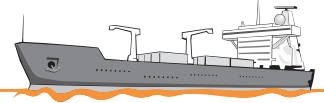

29.602.IMO	3	FLAMMABLE LIQUID
29.603.IMO	4.1	FLAMMABLE SOLID
29.604.IMO	4.2	SPONTANEOUSLY COMBUSTIBLE
29.607.IMO	5.1	OXIDIZING AGENT
29.608.IMO	5.2	ORGANIC PEROXIDE
29.609.IMO	6.1	TOXIC
29.616.IMO	8	CORROSIVE
29.617.00	9	THERMOMETER
29.625.00		EHS Umwelt / EHS environment
29.628.00		EHS Umwelt / EHS environment



250x250mm
Aufkleber
Sticker

Technische Regelwerke / Technical requirements

UNECE R70: Einheitliche Bedingungen für Zulassung von Warntafeln für schwere und lange Fahrzeuge:
 UNECE-R70: uniform conditions for approval of warning plates for heavy and long vehicles.



Gilt nur für Warntafeln; Regelt Anforderungen an Gestaltung, Tagfarbe, Nachtfarbe, Rückstrahlwerte, Widerstand gegenüber Reinigung und Chemikalien, mechanische Stabilität des Trägermaterials und erlaubt :

- Klasse 1: retrorefl. Gelb / fluo. Rot für Lkw und Zugmaschinen
- Klasse 2: retrorefl. Gelb / fluo. Rot für Anhänger und Auflieger
- Klasse 3: retrorefl. Gelb / retrorefl. Rot für Lkw und Zugmaschinen
- Klasse 4: retrorefl. Gelb / retrorefl. Rot für Anhänger und Auflieger
- Klasse 5: retrorefl. Weiß / retrorefl. Rot für alle Fahrzeuge ==> siehe Kap. 5 & 6

Only applies to warning signs; Regulates design requirements, day color, night color, reflectance values, resistance to cleaning and chemicals, mechanical stability of the panels. Following classes apply :

- Class 1: retrorefl. Yellow / fluo. Red for trucks and tractors
- Class 2: retrorefl. Yellow / fluo. Red for trailer and semi-trailer
- Class 3: retrorefl. Yellow / retrorefl. Red for trucks and tractors
- Class 4: retrorefl. Yellow / retrorefl. Red for trailer and semi-trailer
- Class 5: retrorefl. White / retrorefl. Red for all vehicles ==> see Chapter 5, page 10-12)

Heckmarkierungstafeln für schwere und lange Kfz u. Anhänger (beschrieben in ECE R70; erlaubt nach StVZO § 53)

Rearmarking plates for heavy and long vehicles (conform ECE 70 directive)

Die Gesamtlänge eines (Tafel)-Satzes, bestehend aus nur einer, zwei oder vier Kennzeichnungstafel(n), beträgt $1130 \leq L \leq 2300$ mm.

The total length of the panel shall be $1130 \leq L \leq 2300$ mm and may consist of 1, 2 or 4 panels as illustrated.

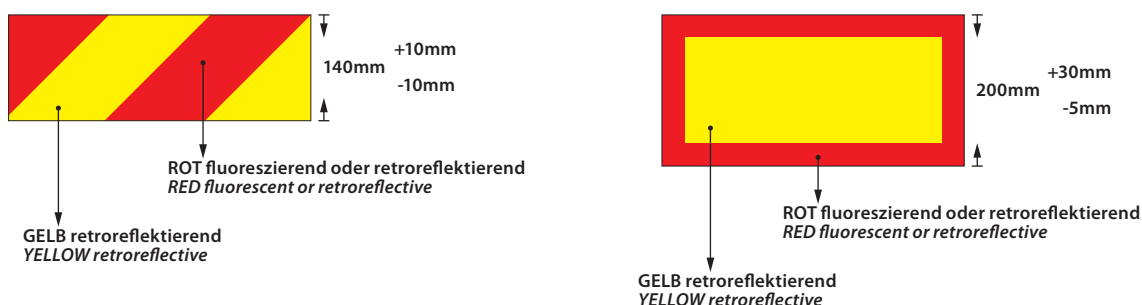

Technische Regelwerke / Technical requirements

UNECE R70: Einheitliche Bedingungen für Zulassung von Warntafeln für schwere und lange Fahrzeuge:
 UNECE-R70: uniform conditions for approval of warning plates for heavy and long vehicles.

Heckmarkierungen
für Kfz
Rearmarkings
for trucks

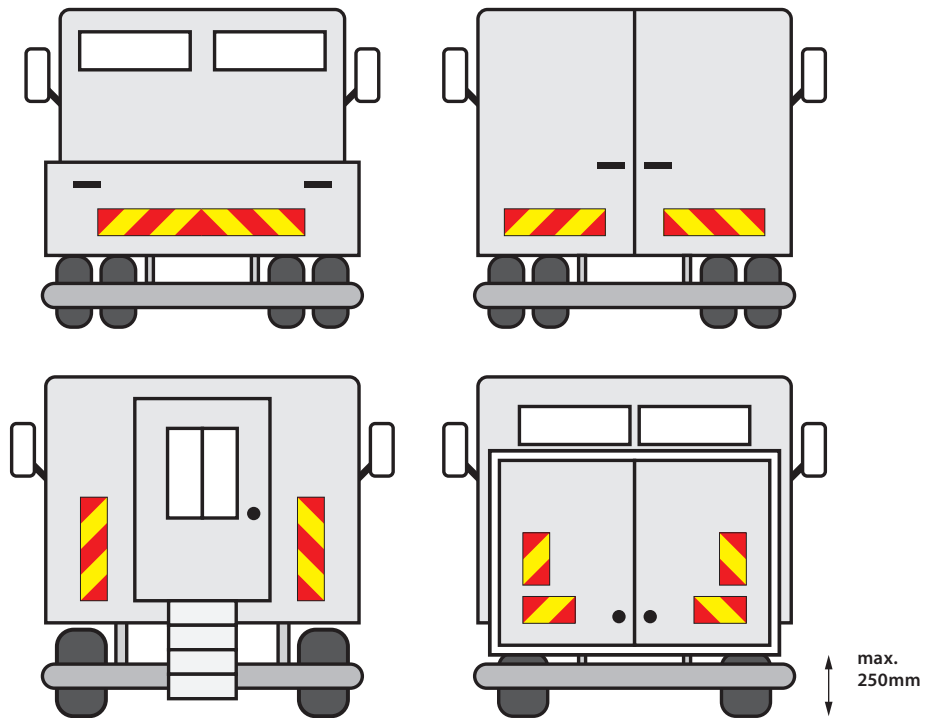

Heckmarkierungen
für Anhänger
Rearmarkings
for trailers

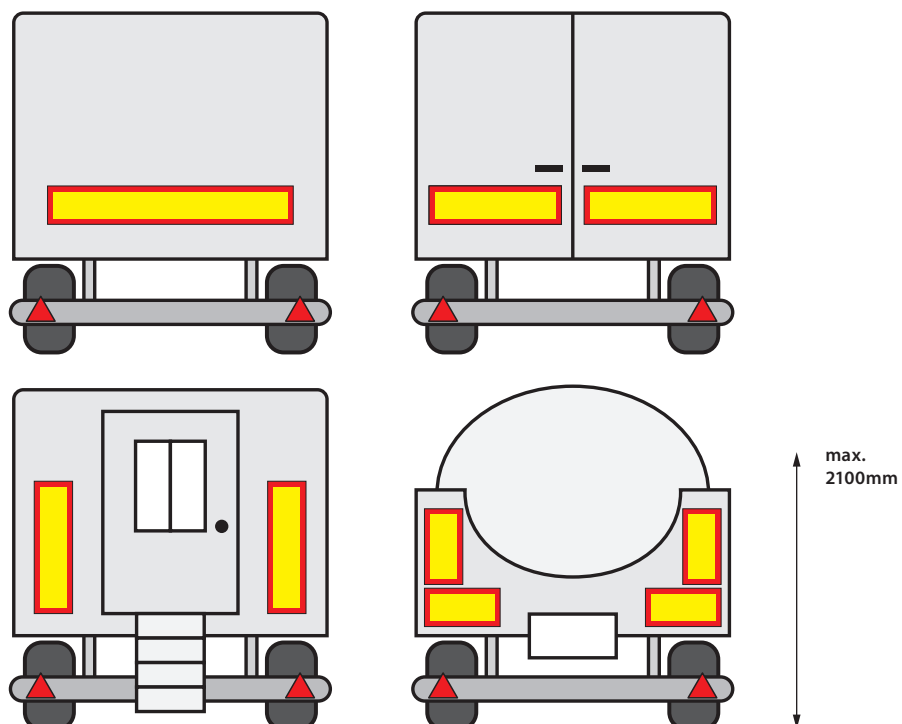

ECE 70-00 Heckmarkierung / ECE 70-00 Rear marking

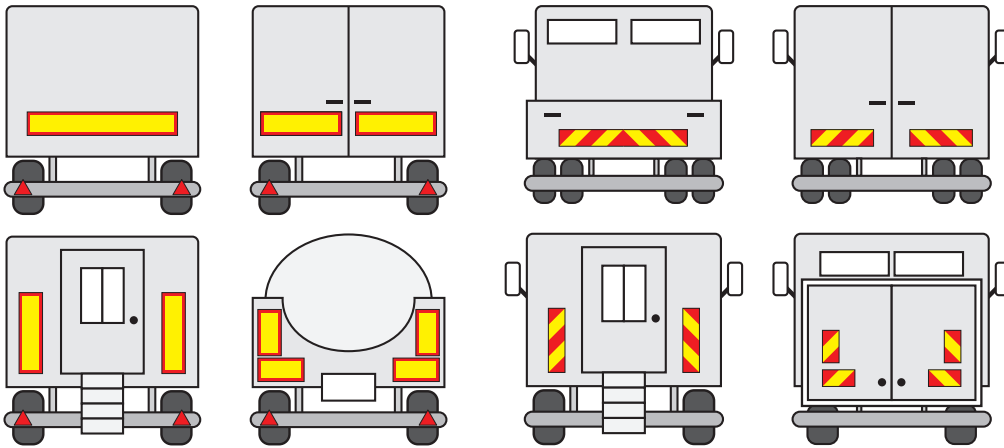

ECE 70-00

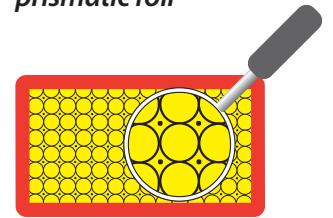
Aluminum 1mm
Aluminum 1mmGelb = Typ 2 Wabenfolie
Yellow = Class 2
prismatic foil

Art. Nr.	Kennzeichnung 1mm Aluminium / Description 1mm Aluminium	Abbildung / Sample
----------	---	--------------------

36.100.00	Vollmarkierung LKW T1132x132x1mm Truckpanel T1132x132x1mm	
36.104.00	Satz Halbmarkierung LKW T566x132x1mm (1x Links + 1x Rechts) Set truckpanels T566x132x1mm (1x Left + 1x Right)	
36.120.00	Satz Viertelmarkierung LKW T283x132x2mm (2x Links + 2x Rechts) Set truckpanels T283x132x1mm (2x Left + 2x Right)	
36.125.00	Vollmarkierung Anhänger R1132x197x1mm Trailerpanel R1132x197x1mm	
36.129.00	Satz Halbmarkierung Anhänger R566x197x1mm (2x) Set trailerpanels R566x197x1mm (2x)	
36.144.00	Satz Viertelmarkierung Anhänger R283x197x1mm (4x) Set trailerpanels R283x197x1mm (4x)	

Aluminium gekantet mit Profile / Bent aluminum with profiles

36.304.00	Satz Halbmarkierung LKW T566x132x1mm (1x Links + 1x Rechts) Set truckpanels T566x132x1mm (1x Left + 1x Right)	
36.329.00	Satz Halbmarkierung Anhänger R566x200x1mm (2x) Set trailer R566x200x1mm (2x)	

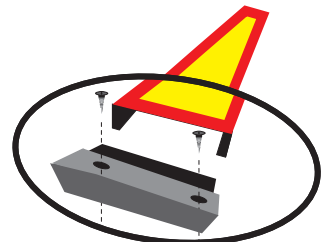

ECE 70-00 Heckmarkierung / ECE 70-00 Rear marking

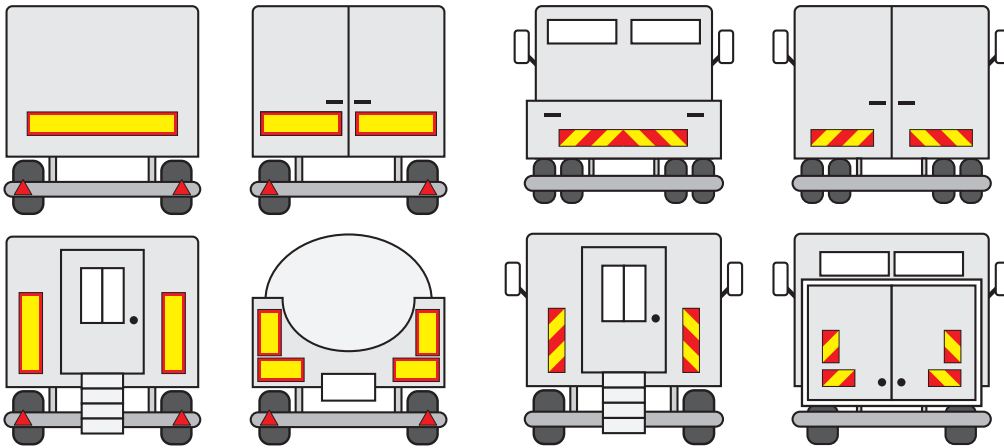

ECE 70-00

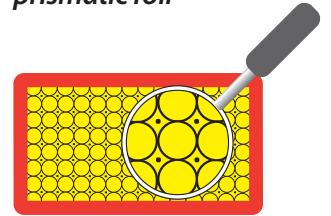
Aluminum 2mm
Aluminum 2mmGelb = Typ 2 Wabenfolie
Yellow = Class 2
prismatic foil

Art. Nr.	Kennzeichnung 2mm Aluminium / Description 2mm Aluminium	Abbildung / Sample
----------	---	--------------------

36.200.00	Vollmarkierung LKW T1132x132x2mm Truckpanel T1132x132x2mm	
36.204.00	Satz Halbmarkierung LKW T566x132x2mm (1x Links + 1x Rechts) Set truckpanels T566x132x2mm (1x Left + 1x Right)	
36.220.00	Satz Viertelmarkierung LKW T283x132x2mm (2x Links + 2x Rechts) Set truckpanels T283x132x2mm (2x Left + 2x Right)	
36.225.00	Vollmarkierung Anhänger R1132x197x2mm Trailerpanel R1132x197x2mm	
36.229.00	Satz Halbmarkierung Anhänger R566x197x2mm (2x) Set trailerpanels R566x197x2mm (2x)	
36.244.00	Satz Viertelmarkierung Anhänger R283x197x2mm (4x) Set trailerpanels R283x197x2mm (4x)	

Selbstklebend / Adhesive

36.900.00	Vollmarkierung LKW T1132x132mm Truckpanel T1132x132mm	
36.904.00	Satz Halbmarkierung LKW T566x132mm (1x Links + 1x Rechts) Set truckpanels T566x132mm (1x Left + 1x Right)	
36.925.00	Vollmarkierung Anhänger R1132x200mm Trailerpanel R1132x200mm	
36.929.00	Satz Halbmarkierung Anhänger R566x200mm (2x) Set trailerpanels R566x200mm (2x)	

ECE 70-01 RF Heckmarkierung / ECE 70-01 Rear marking RF

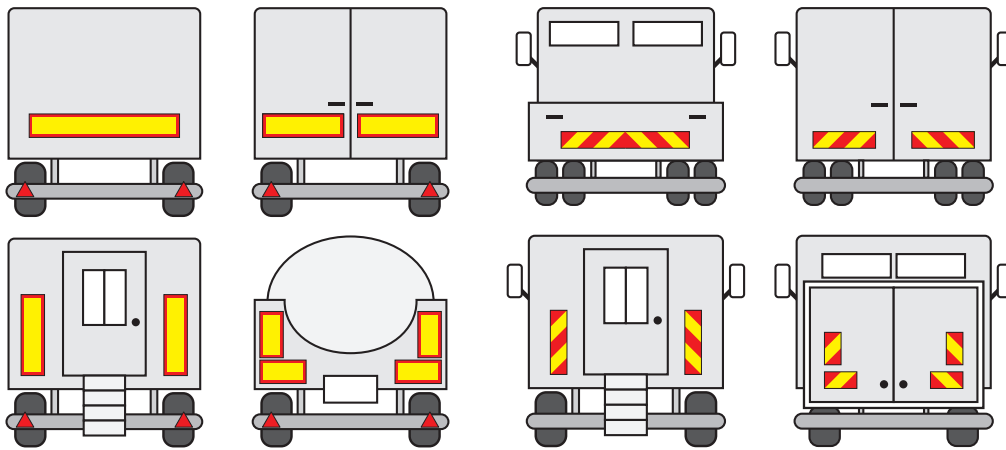
ECE 70-01-RF
 Aluminum 1mm
 Aluminum 1mm

Gelb = Typ 3 Prismenfolie
 Rot = Fluoreszierende Folie
 Yellow = Class 3 prismatic foil
 Red = Fluorescent foil

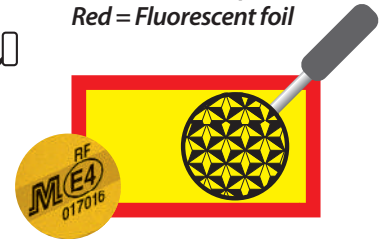

Art. Nr. Kennzeichnung 1mm Aluminium / Description 1mm Aluminium Abbildung / Sample

37.150.00	Vollmarkierung LKW T1132x132x1mm Truckpanel T1132x132x1mm	
37.154.00	Satz Halbmarkierung LKW T566x132x1mm (1x Links + 1x Rechts) Set truckpanels T566x132x1mm (1x Left + 1x Right)	
37.170.00	Satz Viertelmarkierung LKW T283x132x2mm (2x Links + 2x Rechts) Set truckpanels T283x132x1mm (2x Left + 2x Right)	
37.175.00	Vollmarkierung Anhänger R1132x197x1mm Trailerpanel R1132x197x1mm	
37.179.00	Satz Halbmarkierung Anhänger R566x197x1mm (2x) Set trailerpanels R566x197x1mm (2x)	
37.184.00	Satz Viertelmarkierung Anhänger R283x197x1mm (4x) Set trailerpanels R283x197x1mm (4x)	

Aluminium gekantet mit Profile / Bent aluminum with profiles

37.354.00	Satz Halbmarkierung LKW T566x132x1mm (1x Links + 1x Rechts) Set truckpanels T566x132x1mm (1x Left + 1x Right)	
37.375.00	Vollmarkierung Anhänger R1132x200x1mm Trailerpanel R1132x200x1mm	
37.379.00	Satz Halbmarkierung Anhänger R566x200x1mm (2x) Set trailerpanels R566x200x1mm (2x)	

ECE 70-01 RF Heckmarkierung / ECE 70-01 Rear marking RF

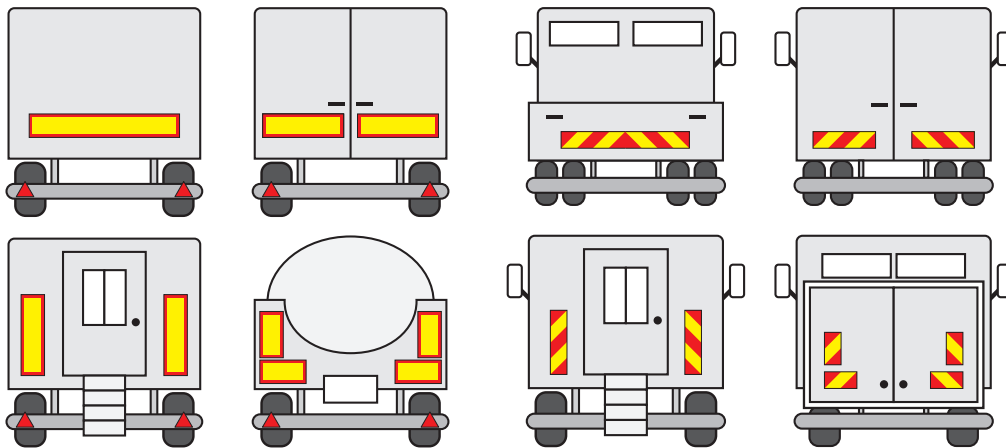
ECE 70-01-RF
 Aluminum 2mm
 Aluminum 2mm

Gelb = Typ 3 Prismenfolie
 Rot = Fluoreszierende Folie
 Yellow = Class 3 prismatic foil
 Red = Fluorescent foil

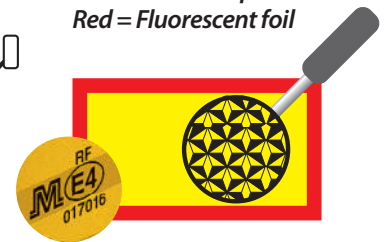

Art. Nr. Kennzeichnung 2mm Aluminium / Description 2mm Aluminium Abbildung / Sample

37.250.00	Vollmarkierung LKW T1132x132x2mm Truckpanel T1132x132x2mm	
37.254.00	Satz Halbmarkierung LKW T566x132x2mm (1x Links + 1x Rechts) Set truckpanels T566x132x2mm (1x Left + 1x Right)	
37.270.00	Satz Viertelmarkierung LKW T283x132x2mm (2x Links + 2x Rechts) Set truckpanels T283x132x2mm (2x Left + 2x Right)	
37.275.00	Vollmarkierung Anhänger R1132x197x2mm Trailerpanel R1132x197x2mm	
37.279.00	Satz Halbmarkierung Anhänger R566x197x2mm (2x) Set trailerpanels R566x197x2mm (2x)	
37.284.00	Satz Viertelmarkierung Anhänger R283x197x2mm (4x) Set trailerpanels R283x197x2mm (4x)	

Selbstklebend / Adhesive

37.950.00	Vollmarkierung LKW T1132x132mm Truckpanel T1132x132mm	
37.954.00	Satz Halbmarkierung LKW T566x132mm (1x Links + 1x Rechts) Set truckpanels T566x132mm (1x Left + 1x Right)	
37.970.00	Satz Viertelmarkierung LKW T283x132mm (2x Links + 2x Rechts) Set truckpanels T283x132mm (2x Left + 2x Right)	
37.975.00	Vollmarkierung Anhänger R1132x200mm Trailerpanel R1132x200mm	
37.979.00	Satz Halbmarkierung Anhänger R566x200mm (2x) Set trailerpanels R566x200mm (2x)	
37.984.00	Satz Viertelmarkierung Anhänger R283x200mm (4x) Set trailerpanels R283x200mm (4x)	

ECE 70-01 RR Heckmarkierung / ECE 70-01 Rear marking RR

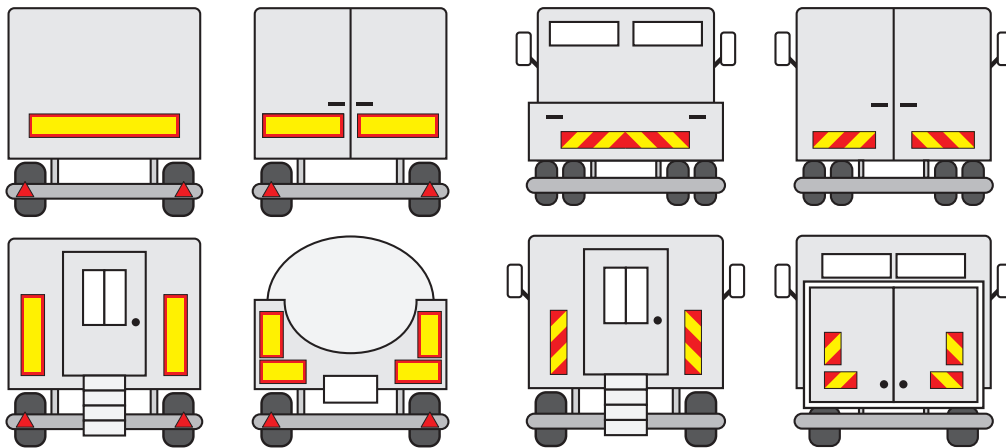
ECE 70-01-RR
 Aluminum 1mm
 Aluminum 1mm

Gelb = Typ 3 Prismenfolie
 Rot = Reflektierend Typ 1
 Yellow = Class 3 prismatic foil
 Red = reflective type 1

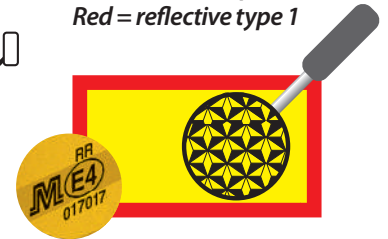

Art. Nr. Kennzeichnung 1mm Aluminium / Description 1mm Aluminium Abbildung / Sample

37.100.00	Vollmarkierung LKW T1132x132x1mm Truckpanel T1132x132x1mm	
37.104.00	Satz Halbmarkierung LKW T566x132x1mm (1x Links + 1x Rechts) Set truckpanels T566x132x1mm (1x Left + 1x Right)	
37.120.00	Satz Viertelmarkierung LKW T283x132x2mm (2x Links + 2x Rechts) Set truckpanels T283x132x1mm (2x Left + 2x Right)	
37.125.00	Vollmarkierung Anhänger R1132x197x1mm Trailerpanel R1132x197x1mm	
37.129.00	Satz Halbmarkierung Anhänger R566x197x1mm (2x) Set trailerpanels R566x197x1mm (2x)	
37.144.00	Satz Viertelmarkierung Anhänger R283x197x1mm (4x) Set trailerpanels R283x197x1mm (4x)	

Aluminium gekantet mit Profil / Bent aluminum with profiles

37.304.00	Satz Halbmarkierung LKW T566x132x1mm (1x Links + 1x Rechts) Set truckpanels T566x132x1mm (1x Left + 1x Right)	
37.325.00	Vollmarkierung Anhänger R1132x200x1mm Trailerpanel R1132x200x1mm	
37.329.00	Satz Halbmarkierung Anhänger R566x200x1mm (2x) Set trailer R566x200x1mm (2x)	

ECE 70-01 RR Heckmarkierung / ECE 70-01 Rear marking RR

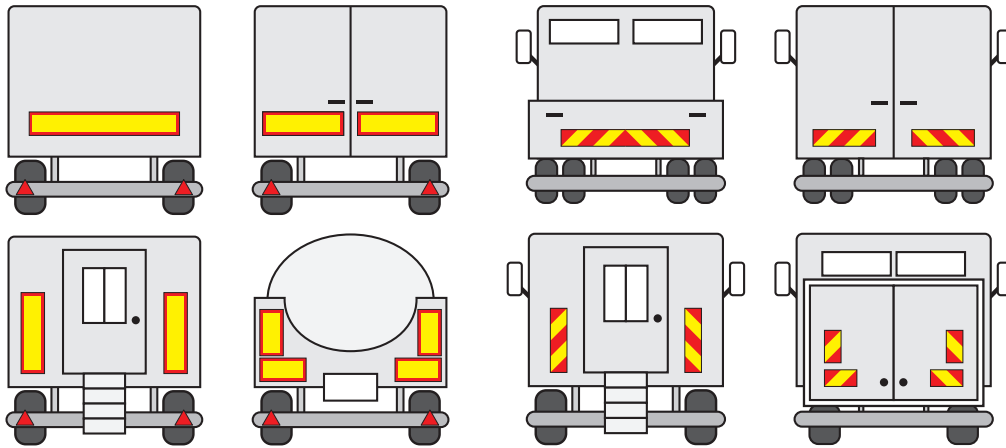
ECE 70-01-RR
 Aluminum 2mm
 Aluminum 2mm

Gelb = Typ 3 Prismenfolie
 Rot = Reflektierend Typ 1
 Yellow = Class 3 prismatic foil
 Red = reflective type 1

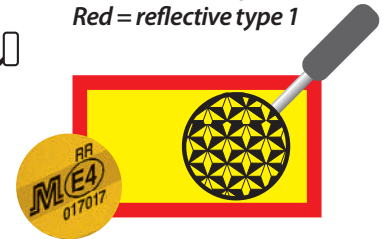

Art. Nr. Kennzeichnung 2mm Aluminium / Description 2mm Aluminium Abbildung / Sample

37.200.00	Vollmarkierung LKW T1132x132x2mm Truckpanel T1132x132x2mm	
37.204.00	Satz Halbmarkierung LKW T566x132x2mm (1x Links + 1x Rechts) Set truckpanels T566x132x2mm (1x Left + 1x Right)	
37.220.00	Satz Viertelmarkierung LKW T283x132x2mm (2x Links + 2x Rechts) Set truckpanels T283x132x2mm (2x Left + 2x Right)	
37.225.00	Vollmarkierung Anhänger R1132x197x2mm Trailerpanel R1132x197x2mm	
37.229.00	Satz Halbmarkierung Anhänger R566x197x2mm (2x) Set trailerpanels R566x197x2mm (2x)	
37.244.00	Satz Viertelmarkierung Anhänger R283x197x2mm (4x) Set trailerpanels R283x197x2mm (4x)	

Selbstklebend / Adhesive

37.900.00	Vollmarkierung LKW T1132x132mm Truckpanel T1132x132mm	
37.904.00	Satz Halbmarkierung LKW T566x132mm (1x Links + 1x Rechts) Set truckpanels T566x132mm (1x Left + 1x Right)	
37.920.00	Satz Viertelmarkierung LKW T283x132mm (2x Links + 2x Rechts) Set truckpanels T283x132mm (2x Left + 2x Right)	
37.925.00	Vollmarkierung Anhänger R1132x200mm Trailerpanel R1132x200mm	
37.929.00	Satz Halbmarkierung Anhänger R566x200mm (2x) Set trailerpanels R566x200mm (2x)	
37.944.00	Satz Viertelmarkierung Anhänger R283x200mm (4x) Set trailerpanels R283x200mm (4x)	

4 ECE 69 / ECE 69-01 DREIECK / TRIANGLE

ECE 69-00 LFV Schild / ECE 69-00 SMV sign

UNECE R69: Einheitliche Bedingungen für Zulassung von Warntafeln für langsam fahrende Fahrzeuge und ihre Anhänger
 UNECE-R69: uniform conditions for approval of warning plates for slow moving vehicles and their trailers

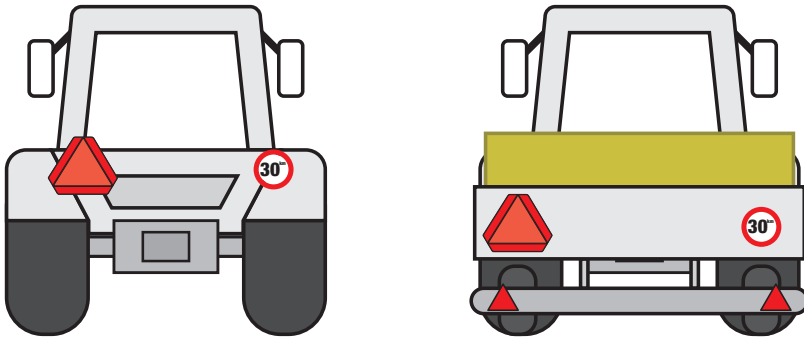

Art. Nr. Kennzeichnung / Description

ECE 69-00 Aluminum 1,2mm Aluminum 1,2mm

Roter Rand = Typ 2 Wabenfolie
 Rot = Fluoreszierende Folie
 Red border = retroreflec. class 2
 Red = Fluorescent foil



Abbildung / Sample

50.902.00 LFV-Schild ECE 69 in 1,2mm Aluminium
 SMV-sign ECE 69 in 1,2mm aluminum

50.901.00 LFV-Schild ECE 69, Aufkleber
 SMV-sign ECE 69 as sticker

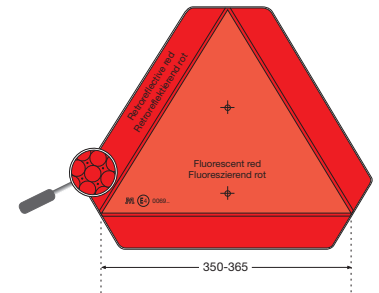

50.921.00 Halterung / Lasche (lang) für LFV-Schild ECE 69, Stahl
 Bracket (long) for SMV-sign ECE 69, steel

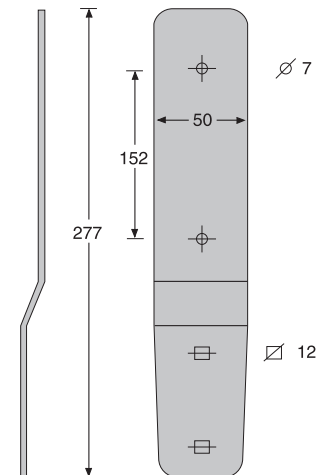

50.931.00 Stütze (klein) für LFV-Schild ECE 69, Stahl
 Support (short) for SMV-sign ECE 69, steel

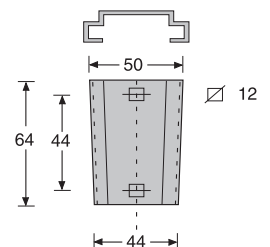

4 ECE 69 / ECE 69-01 DREIECK / TRIANGLE

ECE 69-01 LFV Schild / ECE 69-01 SMV sign

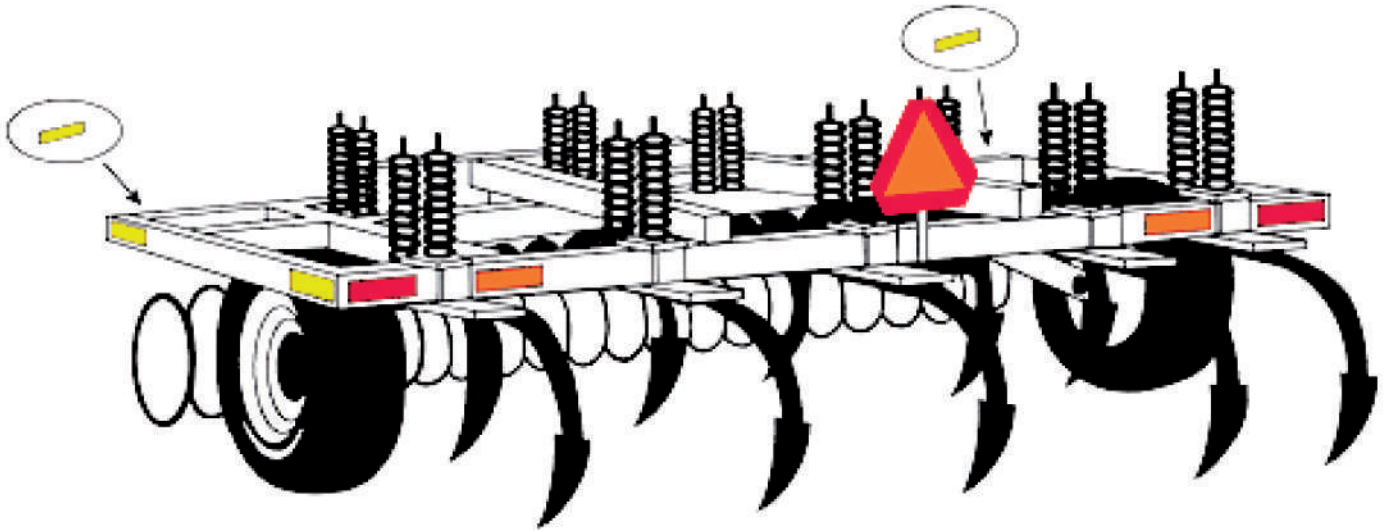

Art. Nr. Kennzeichnung / Description Abbildung / Sample

50.952.00 LFV-Schild ECE 69-01-RF in 1,2mm Aluminium
SMV-sign ECE 69-01-RF in 1,2mm aluminum

ECE 69-01-RF
Aluminum 1,2mm
Aluminum 1,2mm

Roter Rand = Typ 3 Prismenfolie
Rot= Fluoreszierende Folie
Red border = Prismatic foil class 3
Red = Fluorescent foil

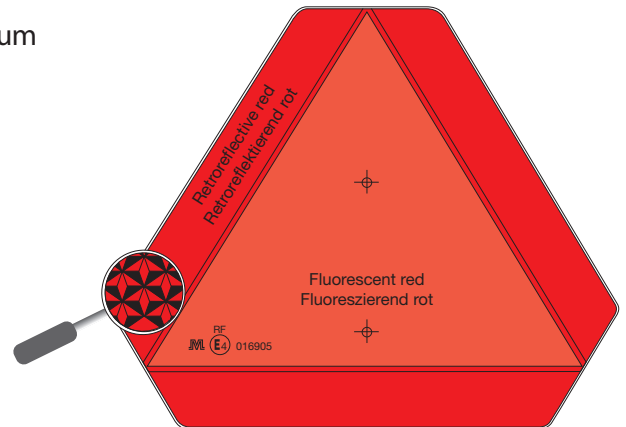

50.942.00 LFV-Schild ECE 69-01-RR in 1,2mm Aluminium
SMV-sign ECE 69-01-RR in 1,2mm aluminum

ECE 69-01-RR
Aluminum 1,2mm
Aluminum 1,2mm

Roter Rand = Typ 3 Prismenfolie
Rot= Reflektierend Klasse 1 Folie
Red border = Prismatic foil class 3
Red = Retroreflective Class 1 foil

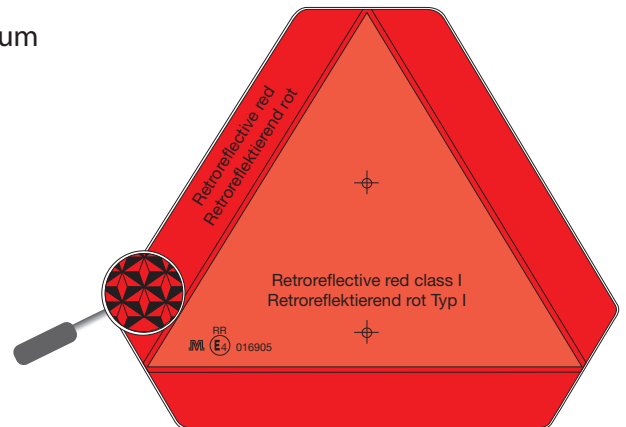

4 ECE 69 / ECE 69-01 DREIECK / TRIANGLE

ASAE 276 LFV Schild USA / ASAE 276 SMV sign USA

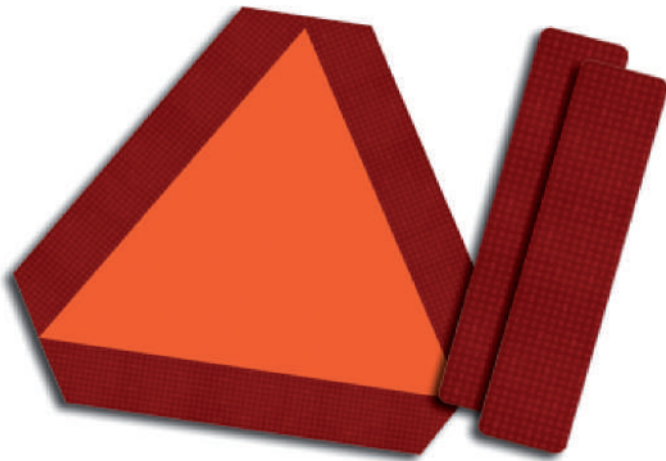

ASAE 276
Aluminum 1,2mm
Aluminum 1,2mm

Roter Rand = Typ 3 Prismenfolie
Rot= Fluoreszierende Folie
Red border = retroreflec. class 3
Red = Fluorescent foil

Art. Nr.	Kennzeichnung / Description	Abbildung / Sample
----------	-----------------------------	--------------------

50.954.00	LFV-Schild USA in 1,2mm Aluminium SMV-sign USA in 1,2mm aluminum	
-----------	---	--

50.955.00	LFV-Schild USA, Aufkleber SMV-sign USA, Sticker
-----------	--

82.112.00	Agri Strip 200x50mm fluorizierend ROT SMV strip 200x50mm fluorescent RED	
-----------	---	--

82.113.00	Agri Strip 200x50mm Typ 3 Prismenfolie GELB SMV strip 200x50mm YELLOW prismatic class 3	
-----------	--	--

82.114.00	Agri Strip 200x50mm Typ 3 Prismenfolie ROT SMV strip 200x50mm RED prismatic class 3	
-----------	--	--

4 ECE 69 / ECE 69-01 DREIECK / TRIANGLE

Reflektoren / Reflectors-catadioptr

Art. Nr. Kennzeichnung / Description Abbildung / Sample

50.880.00 Reflektor ø60mm orange, Selbstklebend
Reflector ø60mm orange, Self adhesive

50.881.00 Reflektor ø60mm rot, Selbstklebend
Reflector ø60mm red, self adhesive

50.882.00 Reflektor ø60mm weiß, Selbstklebend
Reflector ø60mm white, self adhesive



50.886.00 Reflektor ø60mm orange, mit Loch
Reflector ø60mm orange, with hole

50.887.00 Reflektor ø60mm rot, mit Loch
Reflector ø60mm red, with hole

50.888.00 Reflektor ø60mm weiß, mit Loch
Reflector ø60mm white, with hole

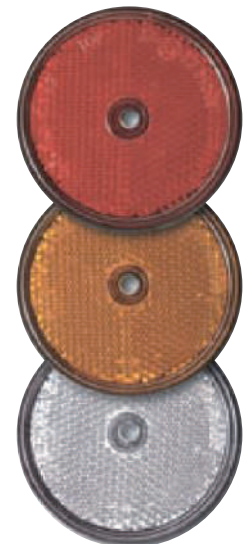

50.883.00 Reflektor Dreieck 135mm rot, Lochbild d=70mm
Reflector triangle 135mm red, holes d=70mm

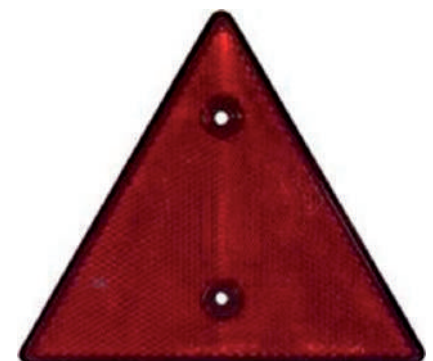

rot/weiß Warntafel mit oder nur Typ 1 Folie / red/white signs with or just class 1 foil

DIN 11030: Kenntlichmachung von Anbaugeräte nach StVZO - Warntafeln und Folien
 DIN 11030 : Identification of hauled vehicles (trailers) - warning signs and warning foil

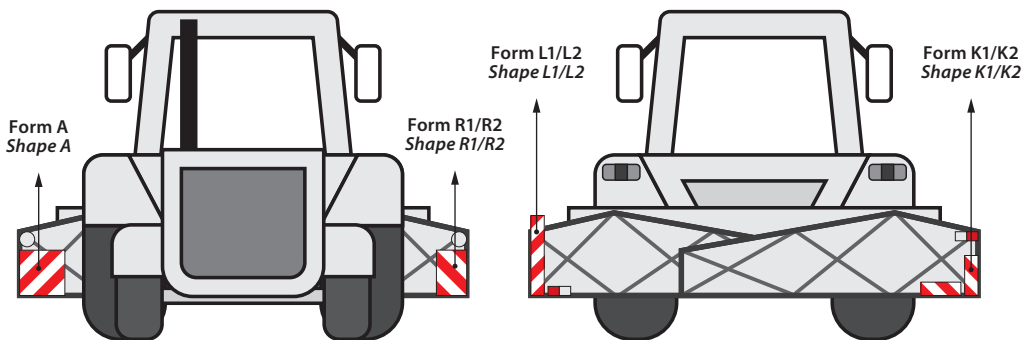

Form A: 423x423mm
 Form R1/R2: 423x282mm
 Form L1/L2: 846x141mm
 Form K1/K2: 423x141mm

Shape A: 423x423mm
 Shape R1/R2: 423x282mm
 Shape L1/L2: 846x141mm
 Shape K1/K2: 423x141mm

Art. Nr. Kennzeichnung Typ 1 Folie / Description Class 1 foil

Abbildung / Sample

- | | | |
|-----------|---|--|
| 50.071.71 | Horizontal linksweisend 846x141mm, Aufkleber
<i>Horizontal leftsided 846x141mm, sticker</i> | |
| 50.072.71 | Horizontal rechtsweisend 846x141mm, Aufkleber
<i>Horizontal rightsided 846x141mm, sticker</i> | |
| 50.371.71 | Horizontal linksweisend 846x141x1mm, Stahlblech
<i>Horizontal leftsided 846x141x1mm, steel</i> | |
| 50.372.71 | Horizontal rechtsweisend 846x141x1mm, Stahlblech
<i>Horizontal rightsided 846x141x1mm, steel</i> | |

- | | | |
|-------------|--|--|
| 50.073.SET | Satz Horizontal 1x links + 1x rechts 423x141mm, Aufkleber
<i>Set horizontal 1x left + 1x right 423x141mm, sticker</i> | |
| 50.073.SET4 | Satz Horizontal 2x links + 2x rechts 423x141mm, Aufkleber
<i>Set horizontal 2x left + 2x right 423x141mm, sticker</i> | |
| 50.074.71 | Horizontal linksweisend 423x141mm, Aufkleber
<i>Horizontal leftsided 423x141mm, sticker</i> | |
| 50.075.71 | Horizontal rechtsweisend 423x141mm, Aufkleber
<i>Horizontal rightsided 423x141mm, sticker</i> | |
| 50.374.71 | Horizontal linksweisend 423x141x1mm, Stahlblech
<i>Horizontal leftsided 423x141x1mm, steel</i> | |
| 50.375.71 | Horizontal rechtsweisend 423x141x1mm, Stahlblech
<i>Horizontal rightsided 423x141x1mm, steel</i> | |

- | | | |
|------------|--|--|
| 50.065.71 | Vertikal linksweisend 423x282mm, Aufkleber
<i>Vertical leftsided 423x282mm, sticker</i> | |
| 50.066.71 | Vertikal rechtsweisend 423x282mm, Aufkleber
<i>Vertical rightsided 423x282, sticker</i> | |
| 50.067.SET | Satz Vertikal 1x links + 1x rechts 423x282mm, Aufkleber
<i>Set vertical 1x left + 1x right 423x282mm, sticker</i> | |

rot/weiß Warntafel mit oder nur Typ 1 Folie / red/white signs with or just class 1 foil

Art. Nr.	Kennzeichnung Typ 1 Folie / Description Class 1 foil	Abbildung / Sample	
50.365.71	Vertikal linksweisend 423x282x1mm, Stahlblech <i>Vertical leftsided 423x282x1mm, steel</i>		
50.366.71	Vertikal rechtsweisend 423x282x1mm, Stahlblech <i>Vertical rightsided 423x282x1mm, steel</i>		
50.367.SET	Satz vertikal 1x links + 1x rechts 423x282x1mm, Stahlblech <i>Set vertical 1x left and 1x right 423x282x1mm, steel</i>		
50.369.71	Vertikal beidseitig beklebt links und rechts 423x282x1mm, Stahlblech <i>Vertical doublesided stickered left and right 423x282x1mm, steel</i>		
50.369.SET	2x Vertikal beidseitig beklebt links und rechts 423x282x1mm, Stahlblech <i>2x Vertical doublesided stickered left and right 423x282x1mm, steel</i>		
50.061.71	Links = rechts 423x423mm, Aufkleber <i>Left = right 423x423mm, sticker</i>		
50.061.27	Links = rechts 423x423mm, Magnetfolie <i>Left = right 423x423mm, magnetic</i>		
50.362.71	Links = rechts 423x423x1mm, Stahlblech <i>Left = right 423x423x1mm, steel</i>		
50.362.71.02	Links = rechts 423x423x1mm, Stahlblech mit Kantenschutz <i>Left = right 423x423x1mm, steel with protectionedge</i>		
50.368.00	Beidseitig links = rechts 423x423x1mm, Stahlblech <i>Doublesided left = right 423x423x1mm, steel</i>		
50.368.02	Beidseitig links = rechts 423x423x1mm, Stahlblech mit Kantenschutz <i>Doublesided left = right 423x423x1mm, steel with protectionedge</i>		
50.261.00	Links = rechts 423x423x2mm, Aluminium <i>Left = right 423x423x2mm, aluminum</i>		
50.263.00	Beidseitig links = rechts 423x423x2mm, Aluminium <i>Doublesided left = right 423x423x2mm, aluminum</i>		
50.363.00	Linksweisend 423x423x1mm, horizontal klappbar, Stahlblech <i>Leftsided 423x423x1mm, horizontally foldable, steel</i>		
50.363.02	Linksweisend 423x423x1mm, horizontal klappbar, Stahlblech mit Kantenschutz <i>Leftsided 423x423x1mm, horizontally foldable, steel with protectionedge</i>		
50.364.00	Rechtsweisend 423x423x1mm, horizontal klappbar, Stahlblech <i>Rightsided 423x423x1mm, horizontally foldable, steel</i>		
50.364.02	Rechtsweisend 423x423x1mm, horizontal klappbar, Stahlblech mit Kantenschutz <i>Rightsided 423x423x1mm, horizontally foldable, steel with protectionedge</i>		
50.378.71.02	Horizontal linksweisend 564x282x1mm, Stahlblech mit Kantenschutz <i>Horizontal leftsided 564x282x1mm, steel with protectionedge</i>		
50.377.71.02	Horizontal rechtsweisend 564x282x1mm, Stahlblech mit Kantenschutz <i>Horizontal rightsided 564x282x1mm, steel with protectionedge</i>		

Ⓑ Ⓓ rot/weiß Warntafel mit Typ 2 Folie / red/white signs with class 2 foil

DIN30710: Sicherheitskennzeichnung von Fahrzeugen und Geräten
DIN30710: Safety marking of vehicles and equipment

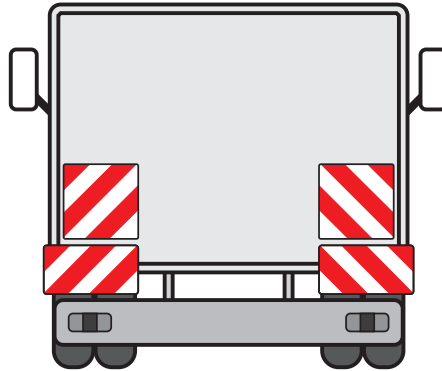

Form A: 423x423mm
 564x282mm
 423x423mm
 500x500mm

Shape A: 423x423mm
 564x282mm
 423x423mm
 500x500mm

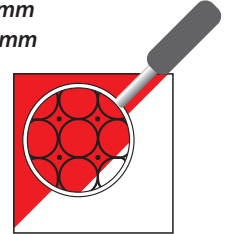

Art. Nr.	Kennzeichnung Typ 2 Folie / Description Class 2 foil	Abbildung / Sample
50.391.00	Horizontal linksweisend 846x141x1mm, Stahlblech <i>Horizontal leftsided 846x141x1mm, Steel</i>	
50.392.00	Horizontal rechtsweisend 846x141x1mm, Stahlblech <i>Horizontal rightsided 846x141x1mm, Steel</i>	
50.393.00	Beidseitig links = rechts 846x141x1mm, Stahlblech <i>Doublesided left = right 846x141x1mm, Steel</i>	
50.397.00	Vertikal linksweisend 564x282x1mm, Stahlblech <i>Vertical leftsided 564x282x1mm, Steel</i>	
50.398.00	Vertikal rechtsweisend 564x282x1mm, Stahlblech <i>Horizontal rightsided 564x282x1mm, Steel</i>	
50.399.00	Beidseitig links = rechts 564x282x1mm, Stahlblech <i>Doublesided left = right 564x282x1mm, Steel</i>	
50.087.00	Links = rechts 423x423mm, Aufkleber <i>Left = right 423x423mm, Sticker</i>	
50.382.00	Links = rechts 423x423x1mm, Stahlblech <i>Left = right 423x423x1mm, Steel</i>	
50.388.00	Beidseitig links = rechts 423x423x1mm, Stahlblech <i>Doublesided left = right 423x423x1mm, Steel</i>	
50.383.00	Linksweisend 423x423x1mm, horizontal klappbar, Stahlblech <i>Leftsided 423x423x1mm, horizontally foldable, steel</i>	
50.384.00	Rechtsweisend 423x423x1mm, horizontal klappbar, Stahlblech <i>Rightsided 423x423x1mm, horizontally foldable, steel</i>	

Ⓑ Ⓓ rot/weiß Warntafel mit Typ 2 Folie / red/white signs with class 2 foil

DIN30710: Sicherheitskennzeichnung von Fahrzeugen und Geräten
DIN30710: Safety marking of vehicles and equipment

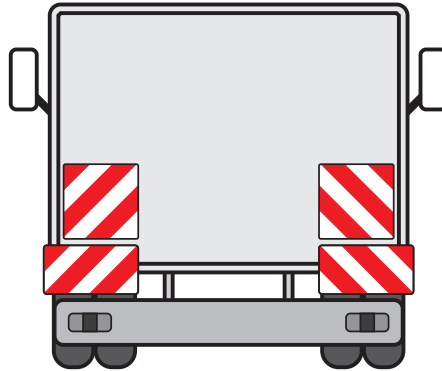

Form A: 423x423mm
 564x282mm
 423x423mm
 500x500mm

Shape A: 423x423mm
 564x282mm
 423x423mm
 500x500mm

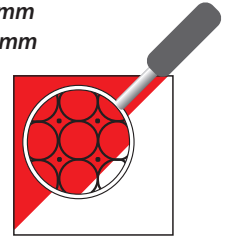

Art. Nr.	Kennzeichnung Typ 2 Folie / Description Class 2 foil	Abbildung / Sample
32.400.00	Links = rechts 423x423x2mm, Aluminium Left = right 423x423x2mm, aluminum	 Parkwarntafel Form A Warningsign shape A
32.400.02	Links = rechts 423x423x2mm, Aluminium mit kantenschutz Left = right 423x423x2mm, aluminum, with protectionedge	
33.400.00	Links = rechts 423x423x1mm, Stahlblech Left = right 423x423x1mm, steel	
33.400.02	Links = rechts 423x423x1mm, Stahlblech mit kantenschutz Left = right 423x423x1mm, steel with protectionedge	
32.401.00	Linksweisend 423x423x2mm, horizontal klappbar, Aluminium Leftsided 423x423x2mm, horizontally foldable, aluminum	  Parkwarntafel Form A Warningsign shape A
32.401.02	Linksweisend 423x423x2mm, horizontal klappbar, Alu mit kantenschutz Leftsided 423x423x2mm, horizontally foldable, alu with protectionedge	
32.402.00	Rechtsweisend 423x423x2mm, horizontal klappbar, Aluminium Rightsided 423x423x2mm, horizontally foldable, aluminum	
32.402.02	Rechtsweisend 423x423x2mm, horizontal klappbar, Alu mit kantenschutz Rightsided 423x423x2mm, horizontally foldable, alu with protectionedge	
33.401.00	Linksweisend 423x423x1mm, horizontal klappbar, Stahlblech Leftsided 423x423x1mm, horizontally foldable, steel	
33.401.02	Linksweisend 423x423x1mm, hor. klappbar, Stahlblech mit kantenschutz Leftsided 423x423x1mm, hor. foldable, steel with protectionedge	
33.402.00	Rechtsweisend 423x423x1mm, horizontal klappbar, Stahlblech Rightsided 423x423x1mm, horizontally foldable, steel	
33.402.02	Rechtsweisend 423x423x1mm, horizontal klappbar, Stahlblech mit kantenschutz Rightsided 423x423x1mm, horizontally foldable, steel with protectionedge	
50.231.00	Links = rechts 500x500x2mm, Aluminium Left = right 500x500x2mm, aluminum	
50.231.DZ	Beidseitig links = rechts 500x500x2mm, Aluminium Doublesided left = right 500x500x2mm, aluminum	

ⓑ ⓓ rot/weiß Parkwarntafel mit Typ 3 Folie / red/white parkingsign with class 3 foil

Technische Anforderungen an Fahrzeugteile bei der Bauartprüfung
nach § 22a StVZ (TA), Nr.18b (Park-Warntafel)
*Technical requirements for vehicle parts in the type test
according to § 22a StVZO (TA), No. 18b (parking warning sign).*

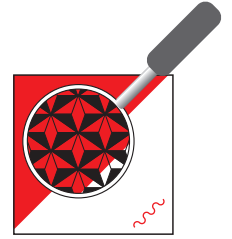

Art. Nr.	Kennzeichnung Typ 3 Folie / Description Class 3 foil	Abbildung / Sample
32.450.00	Linksweisend, 282x282x2mm, Aluminium <i>Leftsided, 282x282x2mm, aluminum</i>	 Parkwarntafel Form B Warningsign shape B
32.455.00	Rechtsweisend, 282x282x2mm, Aluminium <i>Rightsided, 282x282x2mm, aluminum</i>	
32.460.00	Beidseitig, links und rechts, 282x282x2mm, Aluminium <i>Doublesided, left and right, 282x282x2mm, aluminum</i>	
33.450.00	Linksweisend, 282x282x1mm, Stahlblech <i>Leftsided, 282x282x1mm, steel</i>	
33.455.00	Rechtsweisend, 282x282x1mm, Stahlblech <i>Rightsided, 282x282x1mm, steel</i>	
33.460.00	Beidseitig, links und rechts 282x282x1mm, Stahlblech <i>Doublesided, left and right, 282x282x1mm, steel</i>	
32.451.00	Linksweisend, klappbar, 282x282x2mm, Aluminium <i>Leftsided, foldable, 282x282x2mm, aluminum</i>	 Parkwarntafel Form B Warningsign shape B
32.451.02	Linksweisend, klappbar, 282x282x2mm, Aluminium, mit Kantenschutz <i>Leftsided, foldable, 282x282x2mm, aluminum, with protectionedge</i>	
32.452.00	Rechtsweisend, klappbar, 282x282x2mm, Aluminium <i>Rightsided, foldable, 282x282x2mm, aluminum</i>	
32.452.02	Rechtsweisend, klappbar, 282x282x2mm, Aluminium, mit Kantenschutz <i>Rightsided, foldable, 282x282x2mm, aluminum, with protectionedge</i>	
33.451.00	Linksweisend, klappbar, 282x282x1mm, Stahlblech <i>Leftsided, foldable, 282x282x1mm, steel</i>	
33.451.02	Linksweisend, klappbar, 282x282x1mm, Stahlblech, mit Kantenschutz <i>Leftsided, foldable, 282x282x1mm, steel, with protectionedge</i>	
33.452.00	Rechtsweisend, klappbar, 282x282x1mm, Stahlblech <i>Rightsided, foldable, 282x282x1mm, steel</i>	
33.452.02	Rechtsweisend, klappbar, 282x282x1mm, Stahlblech, mit Kantenschutz <i>Rightsided, foldable, 282x282x1mm, steel, with protectionedge</i>	

Ⓕ Ⓓ Rollen in Typ 1 und Typ 2 / Rolls in Class 1 and Class 2



Art. Nr.	Kennzeichnung / Description	Abbildung / Sample
81.143.TPSET	Satz Rollen TPESC-A links- und rechtsweisend 141mmx9M <i>Set of rolls TPESC-A left- and rightsided 141mmx9M</i>	<p>Typ 1/ Class 1</p> <p>Links/Left Rechts/Right</p>
81.143.TPL	Rolle TPESC-A linksweisend 141mmx9M <i>Roll TPESC-A leftsided 141mmx9M</i>	
81.143.TPR	Rolle TPESC-A rechtsweisend 141mmx9M <i>Roll TPESC-A rightsided 141mmx9M</i>	
81.143.45.TPSET	Satz Rollen TPESC-A links- und rechtsweisend 141mmx45,7M <i>Set of rolls TPESC-A left- and rightsided 141mmx45,7M</i>	
81.143.45.TPL	Rolle TPESC-A linksweisend 141mmx45,7M <i>Roll TPESC-A leftsided 141mmx45,7M</i>	
81.143.45.TPR	Rolle TPESC-A rechtsweisend 141mmx45,7M <i>Roll TPESC-A rightsided 141mmx45,7M</i>	
81.157.00	Satz Rollen TPESC-A links- und rechtsweisend 70mmx45,7M <i>Set of rolls TPESC-A left- and rightsided 70mmx45,7M</i>	<p>Typ 1/ Class 1</p> <p>Links/Left Rechts/Right</p>
81.157.0L	Rolle TPESC-A linksweisend 70mmx45,7M <i>Roll TPESC-A leftsided 70mmx45,7M</i>	
81.157.0R	Rolle TPESC-A rechtsweisend 70mmx45,7M <i>Roll TPESC-A rightsided 70mmx45,7M</i>	
81.130.00	Satz Rollen TPESC-B links- und rechtsweisend 141mmx9M <i>Set of rolls TPESC-B left- and rightsided 141mmx9M</i>	<p>Typ 2 Frankreich / Class 2 France</p> <p>Links/Left Rechts/Right</p>
81.130.0L	Rolle TPESC-B linksweisend 141mmx9M <i>Roll TPESC-B leftsided 141mmx9M</i>	
81.130.0R	Rolle TPESC-B rechtsweisend 141mmx9M <i>Roll TPESC-B rightsided 141mmx9M</i>	
81.132.00	Satz Rollen TPESC-B links- und rechtsweisend 141mmx45,7M <i>Set of rolls TPESC-B left- and rightsided 141mmx45,7M</i>	
81.133.00	Satz Rollen TPESC-B links- und rechtsweisend 70mmx45,7M <i>Set of rolls TPESC-B left- and rightsided 70mmx45,7M</i>	<p>Typ 2 Frankreich / Class 2 France</p> <p>Links/Left Rechts/Right</p>

ⓓ KFZ-Rollen DIN 30710 Typ 2 / Rolls DIN 30710 Class 2



Art. Nr.	Kennzeichnung / Description Typ 2 Folie / Class 2 foil	Abbildung / Sample
81.120.00	Satz KFZ-Rollen DIN30710 links- und rechtsweisend 141mmx9M <i>Set of rolls DIN30710 left- and rightsided 141mmx9M</i>	<p>Typ 2 KFZ Deutschland / Class 2 Germany</p> <p>Links / Left Rechts / Right</p>
81.120.0L	Rolle KFZ DIN30710 linksweisend 141mmx9M <i>Roll DIN30710 leftsided 141mmx9M</i>	
81.120.0R	Rolle KFZ DIN30710 rechtsweisend 141mmx9M <i>Roll DIN30710 rightsided 141mmx9M</i>	
81.122.00	Satz KFZ-Rollen DIN30710 links- und rechtsweisend 141mmx45,7M <i>Set of rolls DIN30710 left- and rightsided 141mmx45,7M</i>	<p>Typ 2 KFZ Deutschland / Class 2 Germany</p> <p>Links / Left Rechts / Right</p>
81.122.0L	Rolle KFZ DIN30710 linksweisend 141mmx45,7M <i>Roll DIN30710 leftsided 141mmx45,7M</i>	
81.122.0R	Rolle KFZ DIN30710 rechtsweisend 141mmx45,7M <i>Roll DIN30710 rightsided 141mmx45,7M</i>	
81.121.00	Satz KFZ-Rollen DIN30710 links- und rechtsweisend 282mmx9M <i>Set of rolls DIN30710 left- and rightsided 282mmx9M</i>	<p>Typ 2 KFZ Deutschland / Class 2 Germany</p> <p>Links / Left Rechts / Right</p>
81.121.0L	Rolle KFZ DIN30710 linksweisend 282mmx9M <i>Roll DIN30710 leftsided 282mmx9M</i>	
81.121.0R	Rolle KFZ DIN30710 rechtsweisend 282mmx9M <i>Roll DIN30710 rightsided 282mmx9M</i>	
81.121.45.SET	Satz KFZ-Rollen DIN30710 links- und rechtsweisend 282mmx45,7M <i>Set of rolls DIN30710 left- and rightsided 282mmx45,7M</i>	<p>Typ 2 KFZ Deutschland / Class 2 Germany</p> <p>Links / Left Rechts / Right</p>
81.121.45.0L	Rolle KFZ DIN30710 linksweisend 282mmx45,7M <i>Roll DIN30710 leftsided 282mmx45,7M</i>	
81.121.45.0R	Rolle KFZ DIN30710 rechtsweisend 282mmx45,7M <i>Roll DIN30710 rightsided 282mmx45,7M</i>	

rot/weiß Warntafel I - E - NL - RUS / red/white signs I - E - NL - RUS

Art. Nr.	Kennzeichnung / Description	Abbildung / Sample
50.176.00	Italien, 500x500x1mm, Aluminium, Typ 2 <i>Italy, 500x500x1mm, aluminum, Class 2</i>	
50.282.00	Italien, 500x500x2mm, Aluminium, Typ 2 <i>Italy, 500x500x2mm, aluminum, Class 2</i>	
50.280.00	Italien, 423x423x2mm, Aluminium, gelb = Typ 2 / rot = fluoreszierend <i>Italy, 423x423x2mm, aluminum, yellow = Class 2 / Red = Fluorescent foil</i>	
50.281.00	Italien, 564x282x2mm, Aluminium, links und rechts (Satz) gelb = Typ 2 / rot = fluoreszierend <i>Italy, 564x282x2mm, aluminum, left and right (set) yellow = Class 2 / Red = Fluorescent</i>	
50.676.00	Spanien, 500x500x1,3mm, Aluminium, Typ 2, V20 homologiert <i>Spain, 500x500x1,3mm, aluminum, Class 2, V20 homologated</i>	
50.227.00	Die Niederlande, 500x500x2mm, Aluminium ohne Löcher weiß = nicht reflektierend / rot = fluoreszierend <i>The Netherlands, 500x500x2mm, aluminum without holes white = none reflective / Red = Fluorescent</i>	
50.229.00	Die Niederlande, 500x500x2mm, Aluminium mit 4 Löchern weiß = nicht reflektierend / rot = fluoreszierend <i>The Netherlands, 500x500x2mm, aluminum with 4 holes white = none reflective / Red = Fluorescent</i>	
50.221.00	Allgemein Europa, 500x500x2mm, Aluminium, Typ 1 <i>General Europe, 500x500x2mm, aluminum, Class 1</i>	
50.353.92	Rußland, linksweisend, 400x400x1mm, horizontal klappbar Stahlblech, Typ 1 <i>Russia, leftsided, 400x400x1mm, horizontal foldable steel, Class 1</i>	
50.354.92	Rußland, rechtsweisend, 400x400x1mm, horizontal klappbar Stahlblech, Typ 1 <i>Russia, rightsided, 400x400x1mm, horizontal foldable steel, Class 1</i>	

ⓓ Warntafel Frontschild, diverse / Markers frontpanel, various

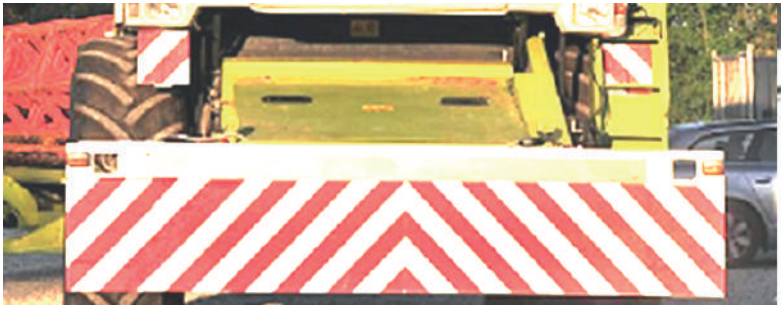

Art. Nr. Kennzeichnung / Description Abbildung / Sample

50.571.00 Links = rechts 423x423x3mm, Kunststoff (Forex) mit 4 Saugnäpfen rot und weiß Typ 2
Left = right 423x423x3mm, plastic (Forex) with 4 separate suctionpads red and white class 2

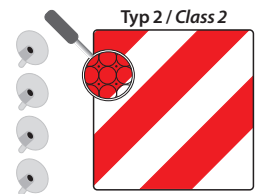

51.474.00 423x423x1,2mm, vertikal klappbar Sandwichmaterial (Hylite), mit Lochbild ohne Metallscharniere, beidseitig, rot und weiß 5921M (vorne li. + hinten re.)
423x423x1,2mm, vertically foldable sandwichmaterial (Hylite), with holepattern no metal hinges, doublesided, red and white 5921M (left front + right back)

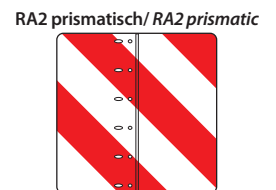

51.475.00 423x423x1,2mm, horizontal klappbar Sandwichmaterial (Hylite), ohne Lochbild ohne Metallscharniere, beidseitig, rot und weiß 5921M (vorne li. + hinten li.)
423x423x1,2mm, horizontally foldable sandwichmaterial (Hylite), without holepattern no metal hinges, doublesided, red and white 5921M (left front + left back)



51.476.00 423x423x1,2mm, horizontal klappbar Sandwichmaterial (Hylite), ohne Lochbild ohne Metallscharniere, beidseitig, rot und weiß Typ 2 (vorne re. + hinten re.)
423x423x1,2mm, horizontally foldable sandwichmaterial (Hylite), without holepattern no metal hinges, doublesided, red and white Class 2 (right front + right back)



50.293.00 Frontschild Mähdrescher 2x 1200x580x2mm + 1x 1190x580x2mm, Aluminium rot-weiß Typ 2, inkl. 20mm weiß Typ3 Folie
Front panel agri set 2x 1200x580x2mm + 1x 1190x580x2mm, Aluminum red-white class 2, incl. 20mm white class 3 foil

Typ 2 / Class 2



Warntafel -Folie prism. 5921M + E-Märke / Markers -foil prism. 5921M + ECE

Auf Grundlage der ECE Regulierungen:

- ECE 48 für Fahrzeuge Klasse M, N, O (Amendierung R104-02 & R70-03 Juni 2015)
- ECE 86-01 für Fahrzeuge der Klasse T, R, S (Amendierung Juni 2017)

UNECE-R70: Einheitliche Bedingungen für die Zulassung von Warntafeln für schwere und lange Fahrzeuge:
Gilt nur für Warntafeln = *Klasse 5: retroreflektierend weiß und rot für alle Fahrzeuge.

UNECE-R104: Standardbedingungen für die Genehmigung der Warnmarkierung für Fahrzeuge der Klassen M, N und O:
Gilt nur für Warnfolien zum aufkleben = * Klasse F: schraffierte warnmarkierung rot und weiß.

Approval of vehicles:

- Regulation ECE 48 (ECE70 & ECE104) for vehicle category M, N, O
- Regulation ECE 86 for vehicle category T, R, S

UNECE-R70 Uniform conditions for approval of warning plates for heavy and long vehicles.
Only applies to warning panels; Regulates design requirements, day color, night color, reflectance values, resistance to cleaning and chemicals, mechanical stability of the panel.
In this case: Class 5: retroreflective white and red for all vehicles.

UNECE-R104 Standard conditions for the approval of warning marking for vehicles of category M, N and O.
Only applies to warning foils; Regulates design requirements, minimum surface area, night color, reflectance values, resistance to cleaning and chemicals;
Here specifically indicated as: Class F warning mark red and white

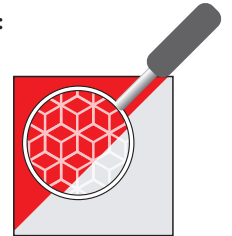

5921M F (E) 104R

5921M 5 (E) 70R

Kenntlichmachung von Anbaugeräten nach ECE R86:

Gilt für Fahrzeugklassen T, R, und S; Gefordert wird Folie nach ECE 104 oder Tafeln nach ECE 70, für Fahrzeuge ab 2,55M Breite verpflichtet, für schmalere optional. Größe und Anzahl der Tafeln bzw. Folienzuschnitte nach Annex 6

Identification of hauled vehicles (trailers) - warningsigns and -foil conform ECE R86:

Applies to vehicle categories T, R and S. Required: marking conform ECE104-class F and mandated for vehicles wider then 2,55M . Warnings conform Annex 6

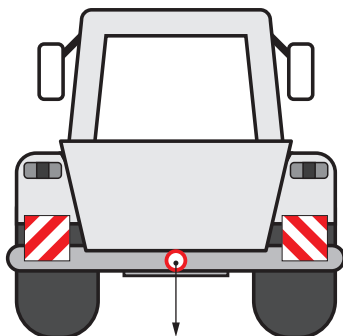

Schutzleuchte und Rückstrahler
Protection light and reflector

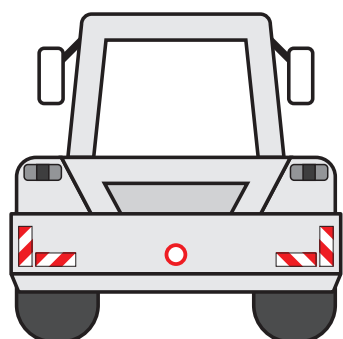
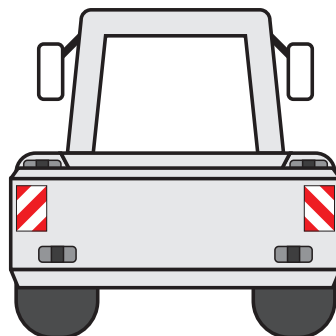

Form A / shape A
423x423mm



Form B / shape B
282x282mm



Form R1 / shape R1
423x282mm



Form K1 / shape K1
423x141mm



Form R2 / shape R2
432x282mm



Form L1 / shape L1
846x141mm



Form L2 / shape L2
846x141mm



Form K2 / shape K2
423x141mm



Warntafel -Folie prism. 5921M nach ECE R86 / Markers -foil prism. 5921M conf. ECE R86

Nach ECE R86:

Gilt für Fahrzeugklassen T, R, und S.

Gefordert wird Folie nach ECE 104 oder Tafel nach ECE 70

Conform ECE R86:

Applies to vehicle classes T, R, and S.

Foil is required according to ECE 104 or panels according to ECE 70

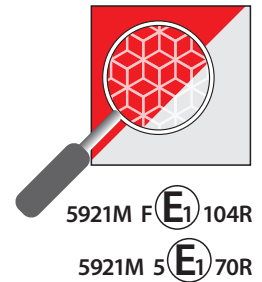

Art. Nr.	Kennzeichnung / Description	Abbildung / Sample
51.071.00	Hor. linksweisend 846x141mm, Aufkleber <i>Hor. leftsided 846x141mm, sticker</i>	<p>Form L1 / shape L1</p>
51.072.00	Hor. rechtsweisend 846x141mm, Aufkleber <i>Hor. rightsided 846x141mm, sticker</i>	
51.371.00	Hor. linksweisend 846x141x1mm, Stahlblech <i>Hor. leftsided 846x141mmx1, steel</i>	
51.372.00	Hor. rechtsweisend 846x141x1mm, Stahlblech <i>Hor. rightsided 846x141x1mm, steel</i>	
51.073.SET	Satz 423x141mm, 2x Aufkleber (1x Links + 1x Rechts) <i>Set 423x141mm, 2x sticker (1x Left + 1x Right)</i>	<p>Form K1 / shape K1</p> <p>Form K2 / shape K2</p>
51.073.SET4	Satz 423x141mm, 4x Aufkleber (2x Links + 2x Rechts) <i>Set 423x141mm, 4x sticker (2x Left + 2x Right)</i>	
51.074.00	Hor. linksweisend 423x141mm, Aufkleber <i>Hor. leftsided 423x141mm, sticker</i>	
51.075.00	Hor. rechtsweisend 423x141mm, Aufkleber <i>Hor. rightsided 423x141mm, sticker</i>	
51.374.00	Hor. linksweisend 423x141x1mm, Stahlblech <i>Hor. leftsided 423x141x1mm, steel</i>	
51.375.00	Hor. rechtsweisend 423x141x1mm, Stahlblech <i>Hor. rightsided 423x141x1mm, steel</i>	
51.065.00	Vert. linksweisend 423x282mm, Aufkleber <i>Vert. leftsided 423x282mm, sticker</i>	<p>Form R1 / shape R1</p> <p>Form R2 / shape R2</p>
51.066.00	Vert. rechtsweisend 423x282mm, Aufkleber <i>Vert. rightsided 423x282mm, sticker</i>	
51.067.SET	Satz 423x282mm, 2x Aufkleber (1x Links + 1x Rechts) <i>Set 423x282mm, 2x sticker (1x Left + 1x Right)</i>	
51.365.00	Vert. linksweisend 423x282x1mm, Stahlblech <i>Vert. leftsided 423x282x1mm, steel</i>	
51.366.00	Vert. rechtsweisend 423x282x1mm, Stahlblech <i>Vert. rightsided 423x282x1mm, steel</i>	
51.367.SET	Satz 423x282x1mm, 2x Stahlblech einseitig (1x Li. + 1x Re.) <i>Set 423x282x1mm, 2x steel singlesided (1x Left + 1x Right)</i>	
51.369.00	423x282x1mm, 1x Stahlblech zweiseitig beklebt (1x Links / Rechts) <i>423x282x1mm, 1x steel doublesided (1x Left / Right)</i>	
51.369.SET	Satz 423x282x1mm, 2x Stahlblech zweiseitig beklebt (2x Links / Rechts) <i>Set 423x282x1mm, 2x steel doublesided (2x Left / Right)</i>	

Warntafel -Folie prism. 5921M nach ECE R86 / Markers -foil prism. 5921M conf. ECE R86

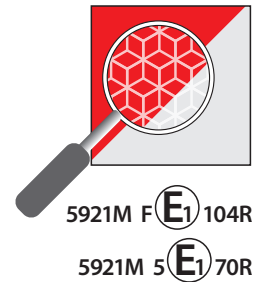
Nach ECE R86:**Gilt für Fahrzeugklassen T, R, und S.****Gefordert wird Folie nach ECE 104 oder Tafel nach ECE 70****Conform ECE R86:****Applies to vehicle classes T, R, and S.****Foil is required according to ECE 104 or panels according to ECE 70**

Art. Nr.	Kennzeichnung / Description	Abbildung / Sample
51.087.00	Links = rechts 423x423mm, Aufkleber <i>Left = right 423x423mm, sticker</i>	
51.362.00	Links = rechts 423x423x1mm, Stahlblech <i>Left = right 423x423x1mm, steel</i>	
51.362.71.02	Links = rechts 423x423x1mm, Stahlblech mit Kantenschutz <i>Left = right 423x423x1mm, steel with protectionedge</i>	
51.368.00	423x423x1mm, Stahlblech beidseitig beklebt (Links / Rechts) <i>423x423x1mm, steel doublesided (Left / Right)</i>	
51.368.02	423x423x1mm, Stahlblech beidseitig beklebt mit Kantenschutz (1x Links / Rechts) <i>423x423x1mm, steel doublesided with protectionedge (1x Left / Right)</i>	
51.363.00	Linksweisend 423x423x1mm, horizontal klappbar, Stahlblech <i>Leftsided 423x423x1mm, horizontally foldable, steel</i>	
51.363.02	Linksweisend 423x423x1mm, hor. klappbar, Stahlblech mit Kantenschutz <i>Leftsided 423x423x1mm, horizontally foldable, steel with protectionedge</i>	
51.364.00	Rechtsweisend 423x423x1mm, horizontal klappbar, Stahlblech <i>Rightsided 423x423x1mm, horizontally foldable, steel</i>	
51.364.02	Rechtsweisend 423x423x1mm, horizontal klappbar, Stahlblech mit Kantenschutz <i>Rightsided 423x423x1mm, horizontally foldable, steel with protectionedge</i>	
51.050.00	Links = rechts 282x282mm, Aufkleber <i>Left = right 282x282mm, sticker</i>	
51.350.00	Links = rechts 282x282x1mm, Stahlblech <i>Left = right 282x282x1mm, steel</i>	
51.350.02	Links = rechts 282x282x1mm, Stahlblech mit Kantenschutz <i>Left = right 282x282x1mm, steel with protectionedge</i>	
51.360.00	282x282x1mm, Stahlblech beidseitig beklebt (Links / Rechts) <i>282x282x1mm, steel doublesided (Left / Right)</i>	
51.360.02	282x282x1mm, Stahlblech beidseitig beklebt mit Kantenschutz (1x Links / Rechts) <i>282x282x1mm, steel doublesided with protectionedge (1x Left / Right)</i>	
51.351.00	Linksweisend 282x282x1mm, horizontal klappbar, Stahlblech <i>Leftsided 282x282x1mm, horizontally foldable, steel</i>	
51.351.02	Linksweisend 282x282x1mm, horizontal klappbar, Stahlblech mit Kantenschutz <i>Leftsided 282x282x1mm, horizontally foldable, steel with protectionedge</i>	
51.352.00	Rechtsweisend 282x282x1mm, horizontal klappbar, Stahlblech <i>Rightsided 282x282x1mm, horizontally foldable, steel</i>	
51.352.02	Rechtsweisend 282x282x1mm, horizontal klappbar, Stahlblech mit Kantenschutz <i>Rightsided 282x282x1mm, horizontally foldable, steel with protectionedge</i>	

Rollen prism. 5921M nach ECE 48 + ECE 86-01 / Rolls prism. 5921M conf. ECE 48 + ECE 86-01

Nach ECE 48 und ECE 86-01: Gilt für Fahrzeugklassen T, R, und S - 2017.
Conform ECE 48 und ECE 86-01: Applies to vehicle classes T, R, and S - 2017.



TPESC-B 14303  **5921M** F  104 R - 004251

Art. Nr.	Kennzeichnung / Description	Abbildung / Sample
51.850.00	Satz Rollen horizontal links- und rechtsweisend 141mmx50M <i>Set of rolls horizontally left- and rightsided 141mmx50M</i>	
51.850.0L	Rolle horizontal linksweisend 141mmx50M <i>Roll horizontally leftsided 141mmx50M</i>	
51.850.0R	Rolle horizontal rechtsweisend 141mmx50M <i>Roll horizontally rightsided 141mmx50M</i>	
51.851.00	Satz Rollen horizontal links- und rechtsweisend 141mmx10M <i>Set of rolls horizontally left- and rightsided 141mmx10M</i>	
51.851.0L	Rolle horizontal linksweisend 141mmx10M <i>Roll horizontally leftsided 141mmx10M</i>	
51.851.0R	Rolle horizontal rechtsweisend 141mmx10M <i>Roll horizontally rightsided 141mmx10M</i>	
51.860.00	Satz Rollen horizontal links- und rechtsweisend 282mmx50M <i>Set of rolls horizontally left- and rightsided 282mmx50M</i>	
51.860.0L	Rolle horizontal linksweisend 282mmx50M <i>Roll horizontally leftsided 282mmx50M</i>	
51.860.0R	Rolle horizontal rechtsweisend 282mmx50M <i>Roll horizontally rightsided 282mmx50M</i>	
51.861.00	Satz Rollen horizontal links- und rechtsweisend 282mmx10M <i>Set of rolls horizontally left- and rightsided 282mmx10M</i>	
51.861.0L	Rolle horizontal linksweisend 282mmx10M <i>Roll horizontally leftsided 282mmx10M</i>	
51.861.0R	Rolle horizontal rechtsweisend 282mmx10M <i>Roll horizontally rightsided 282mmx10M</i>	
51.870.00	Satz Rollen horizontal links- und rechtsweisend 423mmx50M <i>Set of rolls horizontally left- and rightsided 423mmx50M</i>	
51.870.0L	Rolle horizontal linksweisend 423mmx50M <i>Roll horizontally leftsided 423mmx50M</i>	
51.870.0R	Rolle horizontal rechtsweisend 423mmx50M <i>Roll horizontally rightsided 423mmx50M</i>	

Prismatisch 5921M nach ECE 48 + ECE 86-01 / *prismatic 5921M conform ECE 48 + ECE 86-01*

**Auf Grundlage der ECE Regulierungen: nach ECE 48 und ECE 86-01 für Fahrzeugklassen T, R, und S - 2017.
Based on ECE regulations: conform ECE 48 und ECE 86-01 for vehicle classes T, R, and S - 2017.**

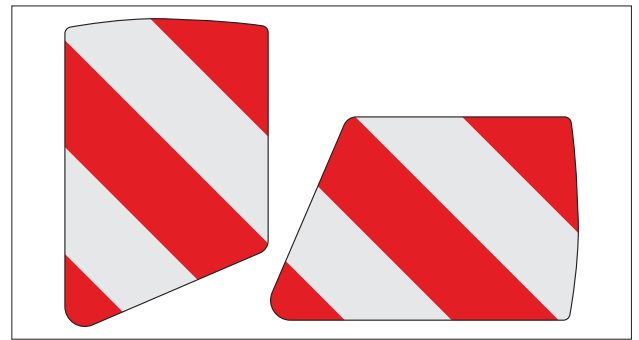
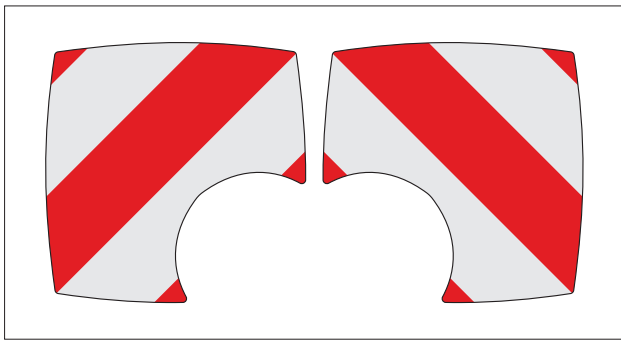
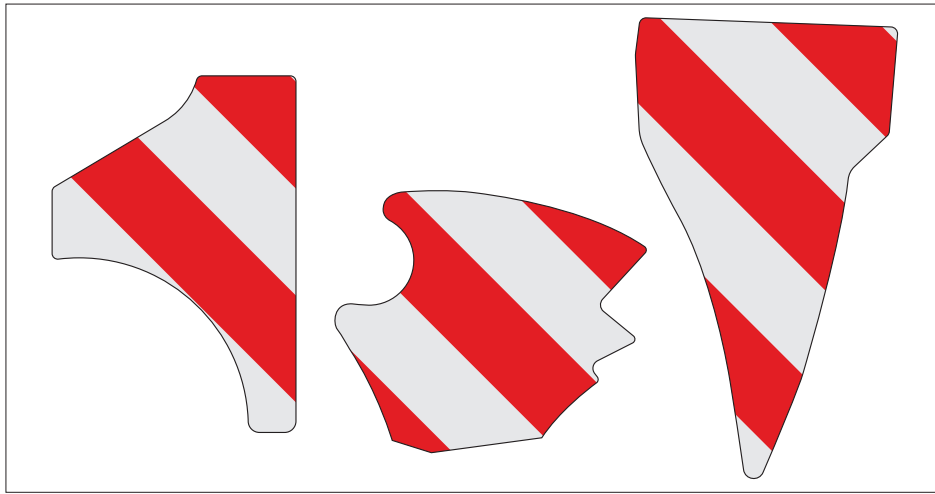

Detail / detail

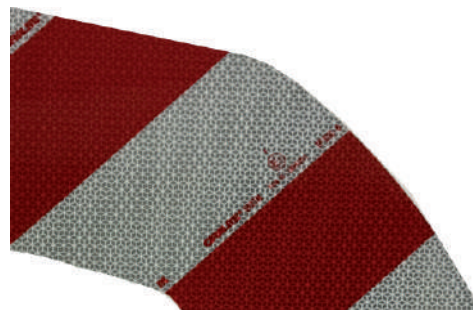

51.8@.SERIE

Sonderzuschnitt in jeder Variant möglich, mit ECE 104-F Marke konform R86-01.
Wir bitten um Anlieferung einer DXF-Datei, Vektor PDF oder EPS Vektordatei.
Achten Sie darauf das die Mindestoberfläche 4 Einheiten enthält von 141x141mm.
Jeder Lay-out ist dazu möglich, bezüglich Radierungen, Lochbild, Größe, usw.
Wir schicken Ihnen gerne einen Vorschlag zur Freigabe...

*Any special shape is possible. With ECE 104 marking compliant to R86-01.
Kindly send us your DXF file, vector PDF or EPS vectorfile.
Take into consideration that each shape must at least match 4 units of 141x141mm.
Every layout is possible in terms of etching, cut-out, size, etc.
We will gladly send you a proposal for approval...*

rot/weiß Warntafel mit LED Beleuchtung / red/white signs with LED lighting

100% LED Technologie mit elektronischer Blinkausfallkontrolle-Überwachung (12V)!
Keine separate LED Kontrollgeräte mehr benötigt. Alles komplett verkabelt mit Bajonetanschlüssen.
100% LED Technology with electronic flashlight control-monitoring (12V)!
No separate LED control devices needed anymore. Everything completely wired with bayonet connections.



Art. Nr.

Kennzeichnung / Description

Abbildung / Sample

1x Satz = für Hinterseite 2x einseitig, LED 3k + 7m Kabelsatz
1x Set = for backside 2x singlesided, LED 3k + 7M cableset

3k = Blink-/Brems-/Positionsbeleuchtung
 3k = Flash-/breaklight/position light

- 50.807.00 1x Satz Hinten (3k) + Typ 1 nach DIN 11030, 423x423mm
 1x Set backside (3k) + Type 1 conform DIN 11030, 423x423mm
- 50.827.00 1x Satz Hinten (3k) + Typ 2 nach DIN 30710, 423x423mm
 1x Set backside (3k) + Type 2 conform DIN 30710, 423x423mm
- 51.900.00 1x Satz Hinten (3k) + Form A: nach R86-01 / ECE104-F KI5, 423x423mm
 1x Set backside (3k) + Shape A: conform R86-01 / ECE104-F KI5, 423x423mm
- 51.901.00 1x Satz Hinten (3k) + Form B: nach R86-01 / ECE104-F KI5
 282x282mm auf Stütze
 1x Set backside (3k) + Shape B: conform R86-01 / ECE104-F KI5
 282x282mm on bracket

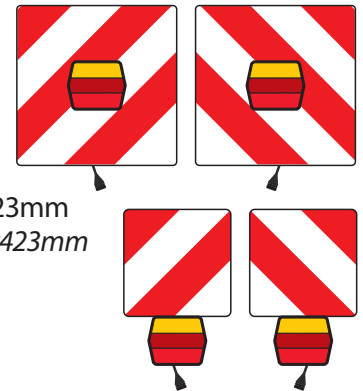

1x Satz = für Vorderseite 2x einseitig, LED weiß Positionslampe 1k, ohne Kabelsatz
1x Set = for frontside 2x singlesided, LED white positionlight 1k, without cableset

1k = Positionslampe
 1k = positionlight

- 50.806.00 1x Satz Vorne (1k) + Typ 1 nach DIN 11030, 423x423mm
 1x Set frontside (1k) + Type 1 conform DIN 11030, 423x423mm
- 50.826.00 1x Satz Vorne (1k) + Typ 2 nach DIN 30710, 423x423mm
 1x Set frontside (1k) + Type 2 conform DIN 30710, 423x423mm
- 51.910.00 1x Satz Vorne (1k) + Form A: nach R86-01 / ECE104-F KI5, 423x423mm
 1x Set frontside (1k) + Shape A: conform R86-01 / ECE104-F KI5, 423x423mm

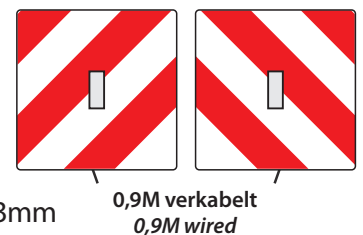

0,9M verkabelt
 0,9M wired

1x Satz = für Vorderseite 2x einseitig, LED weiß 2k + 5M Kabelsatz
1x Set = for frontside 2x singlesided, LED white 2k + 5M cableset

2k = Blinklicht/Positionsbeleuchtung
 2k = Flashlight/position light

- 50.806.2K 1x Satz Vorne (2k) + Typ 1 nach DIN 11030, 423x423mm
 1x Set frontside (2k) + Type 1 conform DIN 11030, 423x423mm
- 50.826.2K 1x Satz Vorne (2k) + Typ 2 nach DIN 30710, 423x423mm
 1x Set frontside (2k) + Type 2 conform DIN 30710, 423x423mm
- 51.915.00 1x Satz Vorne (2k) + Form A: nach R86-01 / ECE104-F KI5, 423x423mm
 1x Set frontside (2k) + Shape A: conform R86-01 / ECE104-F KI5, 423x423mm

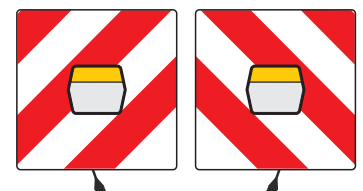

rot/weiß Warntafel mit LED Beleuchtung / red/white signs with LED lighting

100% LED Technologie mit elektronischer Blinkausfallkontrolle-Überwachung (12V)!**Keine separate LED Kontrollgeräte mehr benötigt. Alles komplett verkabelt mit Bajonetanschlüssen.****100% LED Technology with electronic flashlight control-monitoring (12V)!****No separate LED control devices needed anymore. Everything completely wired with bayonet connections.**

Art. Nr.	Kennzeichnung / Description	Abbildung / Sample
	1x Satz für Vorder- / Hinterseite 4x einseitig, LED 3k / 1k + 7m Kabelsatz 1x Set for front- / backside 4x singlesided, LED 3k / 1k + 7M cableset	3k = hinten + 1k = vorne 3k = back + 1k front
51.920.00	1x Satz komplett (3k+1k) + Form A: nach R86-01 / ECE104-F KI5, 423x423mm ACHTUNG! Tafel vorne 0,9M verkabelt 1x Set complete (3k+1k) + Shape A: conform R86-01 / ECE104-F KI5, 423x423mm ATTENTION! Sign front wired 0,9M	
	1x Satz für Vorder- / Hinterseite 4x einseitig, LED 3k / 2k + 7m Kabelsatz 1x Set for front- / backside 4x singlesided, LED 3k / 2k + 7M cableset	3k = hinten + 2k = vorne 3k = back + 2k front
51.921.00	1x Satz komplett (3k+2k) + Form A: nach R86-01 / ECE104-F KI5, 423x423mm ACHTUNG! Tafel vorne 5M Kabelsatz 1x Set complete (3k+2k) + Shape A: conform R86-01 / ECE104-F KI5, 423x423mm ATTENTION! Sign front wired 5M cableset	
	1x Satz für Vorder- / Hinterseite 2x beidseitig, LED 3k / 1k + 7m Kabelsatz 1x Set for front- / backside 2x doublesided, LED 3k / 1k + 7M cableset	3k = hinten + 1k = vorne 3k = back + 1k front
51.930.00	1x Satz komplett (3k+1k) + Form A: nach R86-01 / ECE104-F KI5, 423x423mm 1x Set complete (3k+1k) + Shape A: conform R86-01 / ECE104-F KI5, 423x423mm	
	1x Satz für Vorder- / Hinterseite 2x beidseitig, LED 3k / 2k + 7m Kabelsatz 1x Set for front- / backside 2x doublesided, LED 3k / 2k + 7M cableset	3k = hinten + 2k = vorne 3k = back + 2k front
51.931.00	1x Satz komplett (3k+2k) + Form A: nach R86-01 / ECE104-F KI5, 423x423mm 1x Set complete (3k+2k) + Shape A: conform R86-01 / ECE104-F KI5, 423x423mm	
	1x Satz für Vorder- / Hinterseite 2x beidseitig, LED 3k / 1k + 7m Kabelsatz 1x Set for front- / backside 2x doublesided, LED 3k / 1k + 7M cableset	3k = hinten + 1k = vorne 3k = back + 1k front
51.947.00	1x Satz komplett (3k+1k) + Form K: nach R86-01 / ECE104-F KI5, 423x141mm 1x Set complete (3k+1k) + Shape K: conform R86-01 / ECE104-F KI5, 423x141mm	
	1x Satz für Vorder- / Hinterseite 2x beidseitig, LED 3k / 2k + 7m Kabelsatz 1x Set for front- / backside 2x doublesided, LED 3k / 2k + 7M cableset	3k = hinten + 2k = vorne 3k = back + 2k front
51.948.00	1x Satz komplett (3k+2k) + Form K: nach R86-01 / ECE104-F KI5, 423x141mm 1x Set complete (3k+2k) + Shape K: conform R86-01 / ECE104-F KI5, 423x141mm	

rot/weiß Warntafel mit LED Beleuchtung / red/white signs with LED lighting

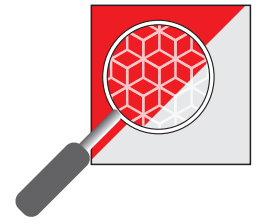
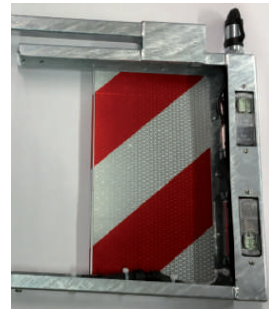

Art. Nr.

Kennzeichnung / Description

Abbildung / Sample

- 50.704.00 **2 Polig und 7 poliger Stecker - beidseitig LED**
2 pole and 7 pole plug - doublesided LED
 Satz 2x Vorne, komplett verkabelt, starr
 Set 2x front, completely wired, flat
- 50.709.00 Satz 2x Hinten, komplett verkabelt, starr
 Set 2x back, completely wired, flat

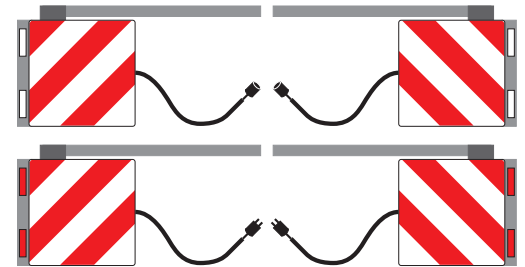

- 50.710.00 **2 Polig und 2 poliger Stecker - beidseitig LED**
2 pole and 2 pole plug - doublesided LED
 Satz 2x Vorne, komplett verkabelt, starr
 Set 2x front, completely wired, flat
- 50.715.00 Satz 2x Hinten, komplett verkabelt, starr
 Set 2x back, completely wired, flat

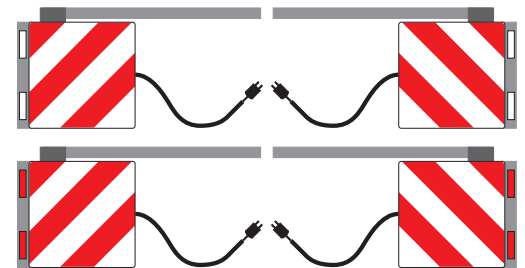

- 50.724.00 **3 Polig und 2 poliger Stecker - beidseitig LED mit Aufsteckrohr**
3 pole connection, 2 pole plug and DIN-plug for warninglight
 Einzelne Tafel VORNE LINKS, komplett verkabelt, starr
 Single panel LEFT FRONT, completely wired, flat



- 50.725.00 Einzelne Tafel VORNE RECHTS, komplett verkabelt, starr
 Single panel RIGHT FRONT, completely wired, flat



- 50.727.00 Einzelne Tafel HINTEN RECHTS, komplett verkabelt, starr
 Single panel LEFT BACK, completely wired, flat



- 50.728.00 Einzelne Tafel HINTEN LINKS, komplett verkabelt, starr
 Single panel RIGHT BACK, completely wired, flat

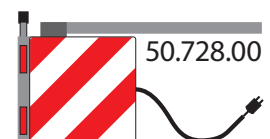

rot/weiß Warntafel mit LED Beleuchtung / red/white signs with LED lighting

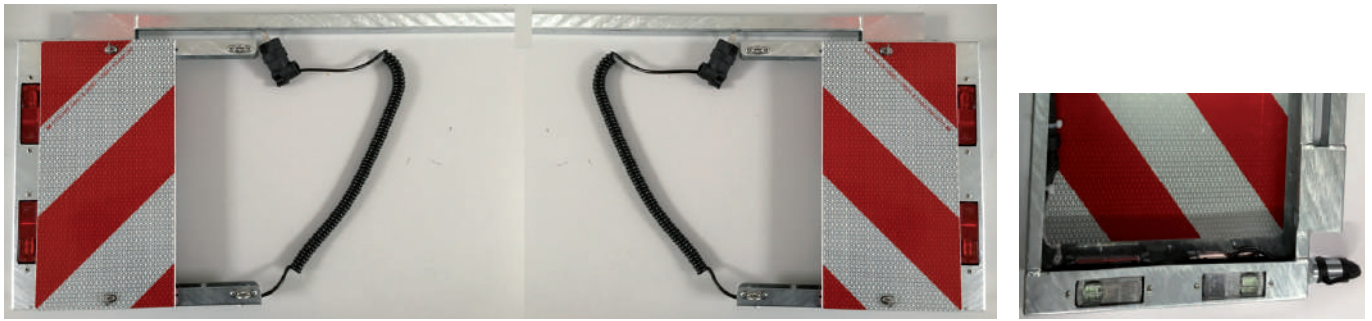

Art. Nr.

Kennzeichnung / Description

Abbildung / Sample

50.760.00	2 Polig und 2 poliger Stecker - beidseitig LED 2 pole and 2 pole plug - doublesided LED Satz 2x Vorne, komplett verkabelt, klappbar Set 2x front, completely wired, foldable	
50.765.00	Satz 2x Hinten, komplett verkabelt, klappbar Set 2x back, completely wired, foldable	
50.769.00	Satz 2x V. + 2x H., komplett verkabelt, klappbar Set 2x front + 2x back, completely wired, foldable (50.760.00 + 50.765.00)	
50.774.00	3 Polig und 2 poliger Stecker - beidseitig LED 3 pole and 2 pole plug - doublesided LED Kombi Satz 2x Hinten, komplett verkabelt, klappbar Links 3 polig mit Aufsteckrohr - rechts 2 polig Combi set 2x back, completely wired, foldable Left 3 pole plug and DIN-plug for warninglight - right 2 pole plug	
50.776.00	3 Polig und 2 poliger Stecker - beidseitig LED mit Aufsteckrohr 3 pole and 2 pole plug + DIN-plug for warninglight Einzelne Tafel VORNE LINKS, komplett verkabelt, klappbar Single panel LEFT FRONT, completely wired, foldable	
50.775.00	Einzelne Tafel VORNE RECHTS, komplett verkabelt, klappbar Single panel RIGHT FRONT, completely wired, foldable	
50.777.00	Einzelne Tafel HINTEN RECHTS, komplett verkabelt, klappbar Single panel LEFT BACK, completely wired, foldable	
50.778.00	Einzelne Tafel HINTEN LINKS, komplett verkabelt, klappbar Single panel RIGHT BACK, completely wired, foldable	
50.779.00	Satz Einzelne Tafeln 2x HINTEN + 2x VORNE, komplett verkabelt, klappbar Set of single panels 2x FRONT + 2x BACK, completely wired, foldable (50.776.00 + 50.775.00 + 50.777.00 + 50.778.00)	

Container / container

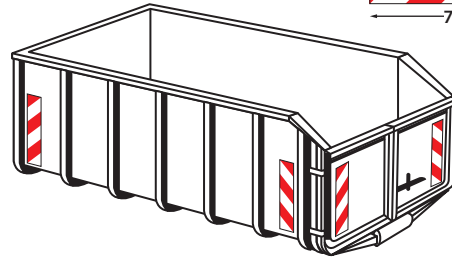
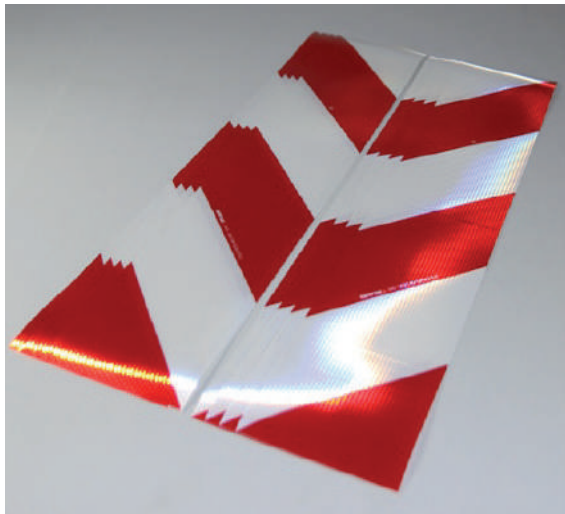

High intensity 5951 prismatic container marking grade

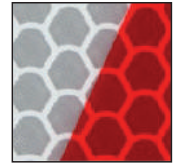
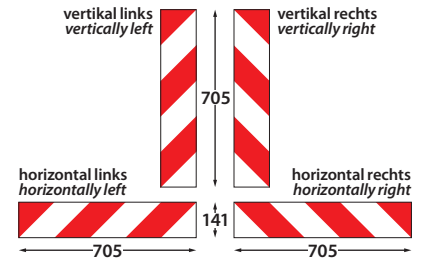

Art. Nr.

Kennzeichnung / Description

Abbildung / Sample

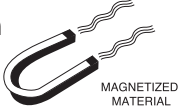
60.001.00	Satz Warnfolien 8-teilig, 4x links + 4x rechts, 705x141mm, Aufkleber <i>Set of 8 containermarkers, 4x left + 4x right, 705x141mm, sticker</i>	
60.002.00	Einzelne Warnschraffe, vertikal rechtsweisend, 705x141mm, Aufkleber <i>Single strip containermarking, vertically rightsided, 705x141mm, sticker</i>	
60.003.00	Einzelne Warnschraffe, vertikal linksweisend, 705x141mm, Aufkleber <i>Single strip containermarking, vertically leftsided, 705x141mm, sticker</i>	
60.005.00	Satz Warnfolien 16-teilig (Skandinavien), 4x links + 4x rechts, 705x141mm plus 8x 141x141mm, Aufkleber <i>Set of 16 containermarkers (Scandinavia), 4x left + 4x right, 705x141mm plus 8x 141x141mm, sticker</i>	
60.001.27	Satz magnetisierte Warnmarkierungen 8-teilig, 4x links + 4x rechts, 705x141mm <i>Set of 8 magnetized containermarkers, 4x left + 4x right, 705x141mm</i>	
60.002.27	Einzelne magnetisierte Warnschraffe, vertikal rechtsweisend, 705x141mm <i>Single strip magnetized containermarking, vertically rightsided, 705x141mm</i>	
60.003.27	Einzelne magnetisierte Warnschraffe, vertikal linksweisend, 705x141mm <i>Single strip magnetized containermarking, vertically leftsided, 705x141mm</i>	
60.011.00	Satz Warnmarkierungen 8-teilig, 4x links + 4x rechts, 705x141x1mm, aluminium <i>Set of 8 containermarkers, 4x left + 4x right, 705x141x1mm, aluminum</i>	
60.012.00	Einzelne Warnschraffe, vertikal rechtsweisend, 705x141x1mm, aluminium <i>Single strip containermarking, vertically rightsided, 705x141x1mm, aluminum</i>	
60.013.00	Einzelne Warnschraffe, vertikal linksweisend, 705x141x1mm, aluminium <i>Single strip containermarking, vertically leftsided, 705x141x1mm, aluminum</i>	

Warnflaggen / warningflags

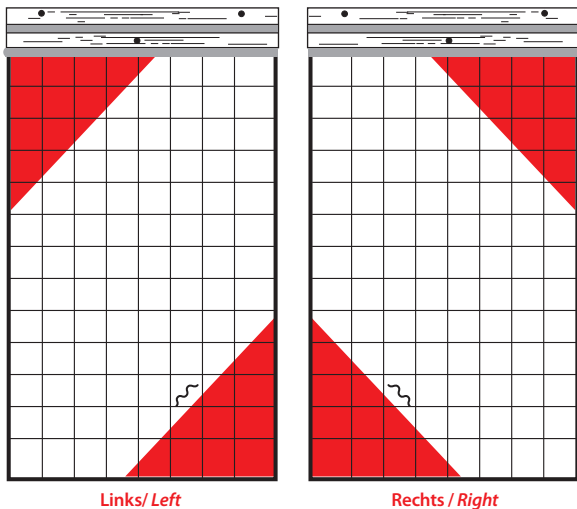

Prismatische Warnflaggen 400x250mm
 Nach StVZO § 53b (1993)
 Reflektierende Warnflagge für Hebebühnen

Prismatic warningflags 400x250mm
 Reflective, homologated warningflags for taillifts.

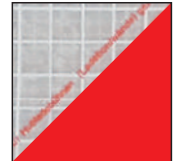

Art. Nr.	Kennzeichnung / Description	Abbildung / Sample
50.300.00	Satz Warnflaggen, 1x linksweisend mit Alu Halterung + 1x rechtsweisend mit Alu Halterung <i>Set of warningflags, 1x leftsided with alu holder + 1x rightsided with alu holder</i>	
50.310.31	Warnflagge, 1x linksweisend mit Alu Halterung <i>Warningflag, 1x leftsided with alu holder</i>	
50.311.31	Warnflagge, 1x rechtsweisend mit Alu Halterung <i>Warningflag, 1x rightsided with alu holder</i>	
50.305.00	Satz Warnflaggen, 1x linksweisend + 1x rechtsweisend <i>Set of warningflags, 1x leftsided + 1x rightsided</i>	
50.310.00	Warnflagge, 1x linksweisend <i>Warningflag, 1x leftsided</i>	
50.311.00	Warnflagge, 1x rechtsweisend <i>Warningflag, 1x rightsided</i>	
50.321.00	1x Aluminium Halterung für einzelne Warnflagge <i>1x Aluminum holder for single warningflag</i>	

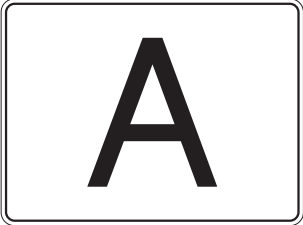
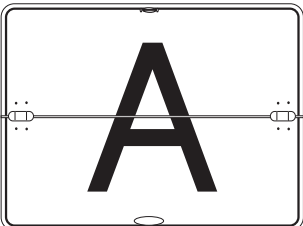
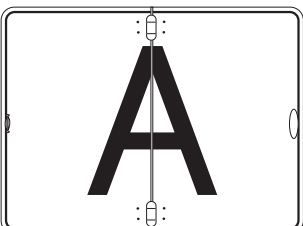

Abfall Warntafel / A-signs Germany

Seit dem 01-07-2014 ist es für alle Fahrzeuge, der Deutschen gewerblichen Abfallbeseitigung und Beforderung, pflicht das "A-Schild" in 400x300mm an zu bringen.
 Since 01-07-2014 it is obligatory for all vehicles, of the German commercial waste disposal and demand, to mount the "A-sign" in 400x300mm.

Art. Nr.	Kennzeichnung / Description	Abbildung / Sample
61.011.00	A-Aufkleber 400x300mm A-sticker 400x300mm	 <p>Reflektierend Typ 1 Reflective class 1</p>
61.011.27	A-Magnetfolie, 400x300x0,8mm A-magnetic foil, 400x300x0,8mm	
61.111.00	A-Tafel, 400x300x1mm, starr, Aluminium A-Sign, 400x300x1mm, flat, aluminum	
61.111.02	A-Tafel, 400x300x1mm, starr, Aluminium, mit Kantenschutz A-Sign, 400x300x1mm, flat, aluminum, with protectionedge	
61.211.00	A-Tafel, 400x300x2mm, starr, Aluminium A-Sign, 400x300x2mm, flat, aluminum	
33.311.00	A-Tafel, 400x300x1mm, starr, Stahlblech A-Sign, 400x300x1mm, flat, steel	
33.311.02	A-Tafel, 400x300x1mm, starr, Stahlblech, mit Kantenschutz A-Sign, 400x300x1mm, flat, steel, with protectionedge	
61.112.00	A-Tafel, 400x300x1mm, horizontal klappbar, Aluminium A-Sign, 400x300x1mm, horizontally foldable, aluminum	 <p>Reflektierend Typ 1 Reflective class 1</p>
61.112.02	A-Tafel, 400x300x1mm, horizontal klappbar, Alu, mit Kantenschutz A-Sign, 400x300x1mm, horizontally foldable, alu, with protectionedge	
61.212.00	A-Tafel, 400x300x2mm, horizontal klappbar, Aluminium A-Sign, 400x300x2mm, horizontally foldable, aluminum	
33.312.00	A-Tafel, 400x300x1mm, horizontal klappbar, Stahlblech A-Sign, 400x300x1mm, horizontally foldable, steel	
33.312.02	A-Tafel, 400x300x1mm, horizontal klappbar, Stahlblech, mit Kantenschutz A-Sign, 400x300x1mm, horizontally foldable, steel, with protectionedge	
61.113.00	A-Tafel, 400x300x1mm, vertikal klappbar, Aluminium A-Sign, 400x300x1mm, vertically foldable, aluminum	 <p>Reflektierend Typ 1 Reflective class 1</p>
61.113.02	A-Tafel, 400x300x1mm, vertikal klappbar, Alu, mit Kantenschutz A-Sign, 400x300x1mm, vertically foldable, alu, with protectionedge	
61.213.00	A-Tafel, 400x300x2mm, vertikal klappbar, Aluminium A-Sign, 400x300x2mm, vertically foldable, aluminum	
33.313.00	A-Tafel, 400x300x1mm, vertikal klappbar, Stahlblech A-Sign, 400x300x1mm, vertically foldable, steel	
33.313.02	A-Tafel, 400x300x1mm, vertikal klappbar, Stahlblech, mit Kantenschutz A-Sign, 400x300x1mm, vertically foldable, steel, with protectionedge	
33.313.36	A-Tafel, 400x300x1mm, vertikal klappbar, Stahlblech, Drehverschluß oben A-Sign, 400x300x1mm, vertically foldable, steel, turnstile mounted in corner	
33.313.36.02	A-Tafel, 400x300x1mm, vertikal klappbar, Stahlblech, mit Kantenschutz, Drehverschluß oben A-Sign, 400x300x1mm, vertically foldable, steel, with protectionedge, turnstile mounted in corner	

Schulbus Deutschland / schoolbus Germany

Schulbusschild nach BOKraft §33 Abs.4 - 250x250mm / 400x400mm / 600x600mm
 Schoolbus-sign, mandatory in Germany - 250x250mm / 400x400mm / 600x600mm

Art. Nr.	Kennzeichnung / Description	Abbildung / Sample
61.040.00	Schulbus Aufkleber 600x600mm <i>Schoolbus sticker 600x600mm</i>	 <p>Reflektierend orange Typ 1 Reflective orange class 1</p>
61.240.00	Schulbus, 600x600x2mm, starr, Aluminium <i>Schoolbus, 600x600x2mm, flat, aluminum</i>	
61.240.02	Schulbus, 600x600x2mm, starr, Aluminium, mit Kantenschutz <i>Schoolbus, 600x600x2mm, flat, aluminum, with protectionedge</i>	
61.045.00	Schulbus Aufkleber 400x400mm <i>Schoolbus sticker 400x400mm</i>	 <p>Reflektierend orange Typ 1 Reflective orange class 1</p>
61.045.27	Schulbus Magnetfolie 400x400mm <i>Schoolbus magnetic foil 400x400mm</i>	
61.045.26.09	Schulbus, 400x400x2mm, starr, Kunststoff (Forex) + 4 einzelne Saugnäpfen <i>Schoolbus, 400x400x2mm, flat, plastic (Forex) with 4 separate suctionpads</i>	
61.245.00	Schulbus, 400x400x2mm, starr, Aluminium <i>Schoolbus, 400x400x2mm, flat, aluminum</i>	
61.245.02	Schulbus, 400x400x2mm, starr, Aluminium, mit Kantenschutz <i>Schoolbus, 400x400x2mm, flat, aluminum, with protectionedge</i>	
61.049.00	Schulbus Aufkleber 250x250mm <i>Schoolbus sticker 250x250mm</i>	
61.049.27	Schulbus Magnetfolie 250x250mm <i>Schoolbus magnetic foil 250x250mm</i>	
61.049.26.09	Schulbus, 250x250x2mm, starr, Kunststoff (Forex) + 4 einzelne Saugnäpfen <i>Schoolbus, 250x250x2mm, flat, plastic (Forex) with 4 separate suctionpads</i>	
61.241.00	Schulbus, 600x600x2mm, horizontal klappbar, Aluminium <i>Schoolbus, 600x600x2mm, horizontally foldable, aluminum</i>	 <p>Reflektierend orange Typ 1 Reflective orange class 1</p>
61.241.02	Schulbus, 600x600x2mm, horizontal klappbar, Aluminium, mit Kantenschutz <i>Schoolbus, 600x600x2mm, horizontally foldable, aluminum, with protectionedge</i>	
61.246.00	Schulbus, 400x400x2mm, horizontal klappbar, Aluminium <i>Schoolbus, 400x400x2mm, horizontally foldable, aluminum</i>	
61.246.02	Schulbus, 400x400x2mm, horizontal klappbar, Aluminium, mit Kantenschutz <i>Schoolbus, 400x400x2mm horizontally foldable, aluminum, with protectionedge</i>	

Schulbus Österreich, Belgien / schoolbus Austria, Belgium

Art. Nr.	Kennzeichnung / Description starr oder klappbar / flat or foldable	Abbildung / Sample
61.055.00	Schulbus Österreich, Aufkleber 400x400mm <i>Schoolbus Austria, sticker 400x400mm</i>	 <p>Reflektierend orange Typ 1 Reflective orange class 1</p>
61.055.27	Schulbus Österreich, Magnetfolie 400x400mm <i>Schoolbus Austria, magnetic foil 400x400mm</i>	
61.255.00	Schulbus Österreich, 400x400x2mm, starr, Aluminium <i>Schoolbus Austria, 400x400x2mm, flat, aluminum</i>	
61.255.02	Schulbus Österreich, 400x400x2mm, starr, Alu, mit Kantenschutz <i>Schoolbus Austria, 400x400x2mm, flat, alu, with protectionedge</i>	
61.256.00	Schulbus Österreich, 400x400x2mm, horizontal klappbar, Aluminium <i>Schoolbus Austria, 400x400x2mm, horizontally foldable, aluminum</i>	 <p>Reflektierend gelb Typ 1 Reflective yellow class 1</p>
61.256.02	Schulbus Österreich, 400x400x2mm, horizontal klappbar, Aluminium, mit Kantenschutz <i>Schoolbus Austria, 400x400x2mm, horizontally foldable, aluminum, with protectionedge</i>	
61.030.00	Schulbus Belgien, Aufkleber 250x250mm <i>Schoolbus Belgium, sticker 250x250mm</i>	 <p>Reflektierend gelb Typ 1 Reflective yellow class 1</p>
61.035.00	Schulbus Belgien, Aufkleber 400x400mm <i>Schoolbus Belgium, sticker 400x400mm</i>	
61.130.00	Schulbus Belgien, 250x250x1mm, starr, Aluminium <i>Schoolbus Belgium, 250x250x1mm, flat, aluminum</i>	
61.135.00	Schulbus Belgien, 400x400x1mm, starr, Aluminium <i>Schoolbus Belgium, 400x400x1mm, flat, aluminum</i>	
61.136.00	Schulbus Belgien, 400x400x1mm, horizontal klappbar, Aluminium <i>Schoolbus Belgium, 400x400x1mm, horizontally foldable, aluminum</i>	
61.236.00	Schulbus Belgien, 400x400x2mm, horizontal klappbar, Aluminium <i>Schoolbus Belgium, 400x400x2mm, horizontally foldable, aluminum</i>	
61.137.00	Schulbus Belgien, 400x400x1mm, vertikal klappbar, Aluminium <i>Schoolbus Belgium, 400x400x1mm, vertically foldable, aluminum</i>	
61.237.00	Schulbus Belgien, 400x400x2mm, vertikal klappbar, Aluminium <i>Schoolbus Belgium, 400x400x2mm, vertically foldable, aluminum</i>	
61.437.00	Schulbus Belgien, 400x400x1,2mm, vertikal klappbar, HYLITE, ohne Metalscharnierung <i>Schoolbus Belgium, 400x400x1,2mm, vertically foldable, HYLITE, without metal hinges</i>	



TIR Tafel, Tare / TIR-sign, Tare

**Transports Internationaux Routiers: Internationaler Straßengütertransport.
Zollrechtliches Versandverfahren zur vorübergehenden Einfuhr bzw. dem Transit von Waren.
Transports Internationaux Routiers: International road haulage.
Customs transit procedure for the temporary importation or transit of goods.**

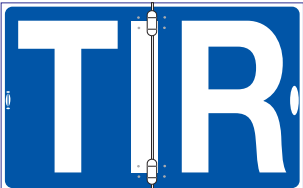
Art. Nr.	Kennzeichnung / Description	Abbildung / Sample																																												
61.005.00	TIR-Aufkleber 400x250mm <i>TIR-sticker 400x250mm</i>																																													
61.105.00	TIR-Tafel, 400x250x1mm, starr, Aluminium <i>TIR-Sign, 400x250x1mm, flat, aluminum</i>																																													
61.105.02	TIR-Tafel, 400x250x1mm, starr, Aluminium, mit Kantenschutz <i>TIR-Sign, 400x250x1mm, flat, aluminum, with protectionedge</i>																																													
61.105.26	TIR-Tafel, 400x250x2mm, starr, Kunststoff (Forex) <i>TIR-Sign, 400x250x2mm, flat, plastic (Forex)</i>																																													
61.106.00	TIR-Tafel, 400x250x1mm, horizontal klappbar, Aluminium <i>TIR-Sign, 400x250x1mm, horizontally foldable, aluminum</i>																																													
61.107.00	TIR-Tafel, 400x250x1mm, vertikal klappbar, Aluminium <i>TIR-Sign, 400x250x1mm, vertically foldable, aluminum</i>																																													
61.107.02	TIR-Tafel, 400x250x1mm, vertikal klappbar, Alu, mit Kantenschutz <i>TIR-Sign, 400x250x1mm, vertically foldable, alu, with protectionedge</i>																																													
61.307.00	TIR-Tafel, 400x250x0,8mm, vertikal klappbar, Edelstahl <i>TIR-Sign, 400x250x0,8mm, vertically foldable, Stainless steel</i>																																													
61.307.02	TIR-Tafel, 400x250x1mm, vertikal klappbar, Edelstahl, mit Kantenschutz <i>TIR-Sign, 400x250x1mm, vertically foldable, Stainless steel, with protectionedge</i>																																													
61.407.00	TIR-Tafel, 400x250x1,2mm, vertikal klappbar, HYLITE, ohne Metallscharnierung <i>TIR-Sign, 400x250x1,2mm, vertically foldable, HYLITE, without metal hinges</i>																																													
61.407.02	TIR-Tafel, 400x250x1mm, vertikal klappbar, Alu, mit Kantenschutz, ohne Metallscharnierung <i>TIR-Sign, 400x250x1,2mm, vertically foldable, alu, with protectionedge, without metal hinges</i>																																													
80.300.00	Satz TARE-Aufkleber, 10x Modell klein 130x100mm <i>Set TARE-stickers, 10x model small 130x100mm</i>	<table border="1"> <tr> <td>PV</td> <td>:</td> <td>.....</td> <td>T</td> </tr> <tr> <td>PTAC</td> <td>:</td> <td>.....</td> <td>T</td> </tr> <tr> <td>PTRA</td> <td>:</td> <td>.....</td> <td>T</td> </tr> <tr> <td>LL</td> <td>:</td> <td>.....</td> <td>m</td> </tr> <tr> <td>S</td> <td>:</td> <td>.....</td> <td>m²</td> </tr> <tr> <td>12345678905</td> <td></td> <td></td> <td></td> </tr> <tr> <td>12345678905</td> <td></td> <td></td> <td></td> </tr> <tr> <td>12345678906</td> <td></td> <td></td> <td></td> </tr> <tr> <td>12345678906</td> <td></td> <td></td> <td></td> </tr> <tr> <td>12340123407</td> <td></td> <td></td> <td></td> </tr> <tr> <td>12340123408</td> <td></td> <td></td> <td></td> </tr> </table>	PV	:	T	PTAC	:	T	PTRA	:	T	LL	:	m	S	:	m ²	12345678905				12345678905				12345678906				12345678906				12340123407				12340123408			
PV	:		T																																										
PTAC	:	T																																											
PTRA	:	T																																											
LL	:	m																																											
S	:	m ²																																											
12345678905																																														
12345678905																																														
12345678906																																														
12345678906																																														
12340123407																																														
12340123408																																														
80.301.00	Satz TARE-Aufkleber, Modell groß 170x130mm <i>Set TARE-stickers, 10x model big 170x130mm</i>																																													

Conform CROW (NL): Specificaties voor materiaal en materiaal / Werk in uitvoering 96a/96b



Geel reflecterend \geq klasse 1. Toegestane afmetingen: L = 5 x BReflektierend gelb \geq Typ 1. Zulässige Abmessungen: L = 5 x BReflective yellow \geq class 1. Allowed dimensions: L = 5 x B

Art. Nr.	Kennzeichnung / Description
62.012.00	Gele retroreflecterende sticker klasse 1 folie, afmeting: 200 x 1000 mm
62.013.00	Gele retroreflecterende sticker klasse 2 folie, afmeting: 200 x 1000 mm
62.212.00	Gele retroreflecterende klasse 1 folie op aluminium 2 mm, afmeting: 200 x 1000 mm
62.213.00	Gele retroreflecterende klasse 2 folie op aluminium 2 mm, afmeting: 200 x 1000 mm
62.042.00	Gele retroreflecterende sticker klasse 1 folie, afmeting: 300 x 1500 mm
62.043.00	Gele retroreflecterende sticker klasse 2 folie, afmeting: 300 x 1500 mm
62.242.00	Gele retroreflecterende klasse 1 folie op aluminium 2 mm, afmeting: 300 x 1500 mm
62.243.00	Gele retroreflecterende klasse 2 folie op aluminium 2 mm, afmeting: 300 x 1500 mm









AFWIJKENDE MATEN: Wij wijzen u er op dat deze maten niet door CROW geadviseerd worden!

62.002.00	Gele retroreflecterende sticker klasse 1 folie, afmeting: 200 x 600 mm
62.002.27	Gele retroreflecterende klasse 1 folie, afmeting: 200 x 600 mm MAGNETISCH
62.202.00	Gele retroreflecterende klasse 1 folie op aluminium 2 mm, afmeting: 200 x 600 mm
62.003.00	Gele retroreflecterende sticker klasse 2 folie, afmeting: 200 x 600 mm
62.003.27	Gele retroreflecterende klasse 2 folie, afmeting: 200 x 600 mm MAGNETISCH
62.005.00	Gele retroreflecterende sticker klasse 2 folie, afmeting: 100 x 400 mm
62.005.27	Gele retroreflecterende klasse 2 folie, afmeting: 100 x 400 mm MAGNETISCH
62.106.09	Gele retroreflecterende klasse 1 folie op aluminium 1 mm, afmeting: 110 x 400 mm met 2 zuignappen
62.032.00	Gele retroreflecterende sticker klasse 1 folie, afmeting: 300 x 1200 mm
62.033.00	Gele retroreflecterende sticker klasse 2 folie, afmeting: 300 x 1200 mm
62.232.00	Gele retroreflecterende klasse 1 folie op aluminium 2 mm, afmeting: 300 x 1200 mm
62.233.00	Gele retroreflecterende klasse 2 folie op aluminium 2 mm, afmeting: 300 x 1200 mm
62.252.00	Gele retroreflecterende klasse 1 folie op aluminium 2 mm, afmeting: 300 x 1800 mm

Diverse Hinweisschilder / Miscellaneous markers

Art. Nr.	Kennzeichnung / Description Nicht reflektierend / Non reflective	Abbildung / Sample
61.072.00	Gelb-schwarz: Österreich, Italien / Yellow-black: Austria, Italy R Ø220mm Routen selbstklebend, gelb-schwarz <i>R Ø220mm Routen, selfadhesive, yellow-black</i>	 
61.073.00	H Ø220mm Höchstgrenzen selbstklebend, gelb-schwarz <i>H Ø220mm Höchstgrenzen, selfadhesive, yellow-black</i>	
61.074.00	E Ø220mm Eingeschränkt selbstklebend, gelb-schwarz <i>E Ø220mm Eingeschränkt, selfadhesive, yellow-black</i>	
61.079.00	R, 400x400mm, Rifuti, selbstklebend, gelb-schwarz <i>R, 400x400mm, Rifuti, selfadhesive, yellow-black</i>	
61.179.00	R, 400x400x1mm, Rifuti, starres Schild, gelb-schwarz <i>R, 400x400x1mm, Rifuti, flat sign, yellow-black</i>	
61.279.00	R, 400x400x2mm, Rifuti, vertikal klappbar, gelb-schwarz <i>R, 400x400x2mm, Rifuti, vertically foldable, yellow-black</i>	
61.070.00	Grün-weiß: Deutschland, Österreich / Green-white: Germany, Austria L Ø220mm Lärmarm, selbstklebend, grün-weiß <i>L Ø220mm Lärmarm, selfadhesive, green-white</i>	
61.070.25	L Ø220mm Lärmarm, 1mm Kunststoff, grün-weiß <i>L Ø220mm Lärmarm, 1mm plastic, green-white</i>	
61.170.00	L Ø220mm Lärmarm, 1mm Aluminium, grün-weiß <i>L Ø220mm Lärmarm, 1mm aluminum, green-white</i>	
61.071.00	U Ø220mm Umweltfreundlich, selbstklebend, grün-weiß <i>U Ø220mm Umweltfreundlich, selfadhesive, green-white</i>	
61.075.00	S Ø220mm Schadstoffarm, selbstklebend, grün-weiß <i>S Ø220mm Schadstoffarm, selfadhesive, green-white</i>	
61.090.00	G Ø220mm Geräuscharm, selbstklebend, grün-weiß <i>G Ø220mm Geräuscharm, selfadhesive, green-white</i>	
61.090.25	G Ø220mm Geräuscharm, Kunststoff, grün-weiß <i>G Ø220mm Geräuscharm, plastic, green-white</i>	
61.094.00	K 150x150mm, Kombiniertes Verkehr, selbstklebend, grün-weiß <i>K 150x150mm, Kombiniertes Verkehr, selfadhesive, green-white</i>	
61.077.00	Grün-schwarz: Italien / Green-black: Italy d, 500x400mm, deperibili, selbstklebend, grün-schwarz <i>d, 500x400mm, deperibili, selfadhesive, green-black</i>	
61.177.00	d, 500x400x1mm, deperibili, starres Schild, grün-schwarz <i>d, 500x400x1mm, deperibili, flat sign, green-black</i>	
61.277.00	d, 500x400x2mm, deperibili, vertikal klappbar, grün-schwarz <i>d, 500x400x2mm, deperibili, vertically foldable, green-black</i>	
61.078.00	a, 500x400mm, agricola, selbstklebend, grün-schwarz <i>a, 500x400mm, agricola, selfadhesive, green-black</i>	
61.178.00	a, 500x400x1mm, agricola, starres Schild, grün-schwarz <i>a, 500x400x1mm, agricola, flat sign, green-black</i>	
61.278.00	a, 500x400x2mm, agricola, vertikal klappbar, grün-schwarz <i>a, 500x400x2mm, agricola, vertically foldable, green-black</i>	

Diverse Hinweisschilder / Miscellaneous markers

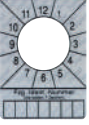
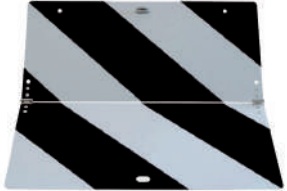
Art. Nr.	Kennzeichnung / Description	Abbildung / Sample
	Länderaufkleber / Country ID-sticker	
69.110.86	NL Länderaufkleber Niederlande, 175x115mm <i>NL Country ID-sticker The Netherlands, 175x115mm</i>	
69.110.70	D Länderaufkleber Deutschland, 175x115mm <i>D Country ID-sticker Germany, 175x115mm</i>	
69.110.71	B Länderaufkleber Belgien, 175x115mm <i>B Country ID-sticker Belgium, 175x115mm</i>	
69.110.72	F Länderaufkleber Frankreich, 175x115mm <i>F Country ID-sticker France, 175x115mm</i>	
69.110.75	DK Länderaufkleber Dänemark, 175x115mm <i>DK Country ID-sticker Denmark, 175x115mm</i>	
	Aufkleber / Sticker	
10.961.00	Nur für Lebensmittel, 610x100mm, Aufkleber <i>Nur für Lebensmittel, 610x100mm, sticker</i>	
10.962.00	Trasporto Liquidi Alimentari, 900x100mm, Aufkleber <i>Trasporto Liquidi Alimentari, 900x100mm, sticker</i>	
10.966.00	Rangierabstand halten, 500x50mm, Aufkleber <i>Rangierabstand halten, 500x50mm, sticker</i>	
	Aufkleber Sicherheitsprüfung / Securitylabel Germany	
80.361.00	60x85mm, Aufkleber versiegelbar <i>60x85mm, sticker safety label</i>	
	Elbe tafel / Sign for German Elbetunnel	
33.315.00	Schwarz/weiß, 400x400x1mm, horizontal klappbar, Stahlblech (Zusatzschild Sondergenehmigung für das durchfahren des Elbetunnels) <i>Black/white 400x400x1mm, horizontally foldable, steel</i> (Additional sign special permission for driving through the Elbe tunnel)	

Geschwindigkeit Niederlande / Speedsign Netherlands

Art. Nr. Kennzeichnung: ø240mm - rot-weiß - nicht reflektierende Folie Abbildung / Sample
 Description: ø240mm - red-white - non-reflective foil

69.100.86/05	Geschwindigkeit Niederlande - 5km Speedsign Netherlands - 5km
69.100.86/06	Geschwindigkeit Niederlande - 6km Speedsign Netherlands - 6km
69.100.86/10	Geschwindigkeit Niederlande - 10km Speedsign Netherlands - 10km
69.100.86/16	Geschwindigkeit Niederlande - 16km Speedsign Netherlands - 16km
69.100.86/20	Geschwindigkeit Niederlande - 20km Speedsign Netherlands - 20km
69.100.86/25	Geschwindigkeit Niederlande - 25km Speedsign Netherlands - 25km
69.100.86/30	Geschwindigkeit Niederlande - 30km Speedsign Netherlands - 30km
69.100.86/35	Geschwindigkeit Niederlande - 35km Speedsign Netherlands - 35km
69.100.86/40	Geschwindigkeit Niederlande - 40km Speedsign Netherlands - 40km
69.100.86/45	Geschwindigkeit Niederlande - 45km Speedsign Netherlands - 45km
69.100.86/50	Geschwindigkeit Niederlande - 50km Speedsign Netherlands - 50km
69.100.86/60	Geschwindigkeit Niederlande - 60km Speedsign Netherlands - 60km
69.100.86/70	Geschwindigkeit Niederlande - 70km Speedsign Netherlands - 70km
69.100.86/80	Geschwindigkeit Niederlande - 80km Speedsign Netherlands - 80km
69.100.86/90	Geschwindigkeit Niederlande - 90km Speedsign Netherlands - 90km
69.100.86/100	Geschwindigkeit Niederlande - 100km Speedsign Netherlands - 100km



ø240mm

Niederlande ø240mm - rot-weiß - nicht reflektierende Folie, laminiert auf einen Untergrund:
 Netherlands ø240mm - red-white - non-reflective foil, laminated onto a background:

69.100.86/xx + 31.942.00	Laminiert auf 1mm Aluminium Laminated on 1mm aluminum
69.100.86/xx + 25.942.00	Laminiert auf 1mm Kunststoff Laminated on 1mm plastic

Geschwindigkeit Belgien - Italien / Speedsign Belgium - Italy

Art. Nr.

Kennzeichnung: rot-weiß / Description: red-white

Abbildung / Sample

69.104.71/30	Geschwindigkeit Belgien - 30km, ø210 mm, reflekt. Typ 1 Folie <i>Speedsign Belgium - 30km, ø210mm, reflective class 1 foil</i>
69.104.71/40	Geschwindigkeit Belgien - 40km, ø210 mm, reflekt. Typ 1 Folie <i>Speedsign Belgium - 40km, ø210mm, reflective class 1 foil</i>
69.104.71/60	Geschwindigkeit Belgien - 60km, ø210 mm, reflekt. Typ 1 Folie <i>Speedsign Belgium - 60km, ø210mm, reflective class 1 foil</i>
69.104.71/70	Geschwindigkeit Belgien - 70km, ø210 mm, reflekt. Typ 1 Folie <i>Speedsign Belgium - 70km, ø210mm, reflective class 1 foil</i>
69.104.71/75	Geschwindigkeit Belgien - 75km, ø210 mm, reflekt. Typ 1 Folie <i>Speedsign Belgium - 75km, ø210mm, reflective class 1 foil</i>
69.104.71/80	Geschwindigkeit Belgien - 80km, ø210 mm, reflekt. Typ 1 Folie <i>Speedsign Belgium - 80km, ø210mm, reflective class 1 foil</i>
69.104.71/90	Geschwindigkeit Belgien - 90km, ø210 mm, reflekt. Typ 1 Folie <i>Speedsign Belgium - 90km, ø210mm, reflective class 1 foil</i>
69.104.71/100	Geschwindigkeit Belgien - 100km, ø210 mm, reflekt. Typ 1 Folie <i>Speedsign Belgium - 100km, ø210mm, reflective class 1 foil</i>

**laminiert auf einen Untergrund: / laminated onto a background:**

69.104.71/xx + 31.941.00	Laminiert auf 1mm Aluminium <i>Laminated on 1mm aluminum</i>
69.104.71/xx + 25.941.00	Laminiert auf 1mm Kunststoff <i>Laminated on 1mm plastic</i>

69.101.79/15	Geschwindigkeit Italien - 15km, ø200 mm, reflekt. Typ 2 Folie <i>Speedsign Italy - 15km, ø200mm, reflective class 2 foil</i>
69.101.79/40	Geschwindigkeit Italien - 40km, ø200 mm, reflekt. Typ 2 Folie <i>Speedsign Italy - 40km, ø200mm, reflective class 2 foil</i>
69.101.79/60	Geschwindigkeit Italien - 60km, ø200 mm, reflekt. Typ 2 Folie <i>Speedsign Italy - 60km, ø200mm, reflective class 2 foil</i>
69.101.79/70	Geschwindigkeit Italien - 70km, ø200 mm, reflekt. Typ 2 Folie <i>Speedsign Italy - 70km, ø200mm, reflective class 2 foil</i>
69.101.79/80	Geschwindigkeit Italien - 80km, ø200 mm, reflekt. Typ 2 Folie <i>Speedsign Italy - 80km, ø200mm, reflective class 2 foil</i>
69.101.79/90	Geschwindigkeit Italien - 90km, ø200 mm, reflekt. Typ 2 Folie <i>Speedsign Italy - 90km, ø200mm, reflective class 2 foil</i>
69.101.79/100	Geschwindigkeit Italien - 100km, ø200 mm, reflekt. Typ 2 Folie <i>Speedsign Italy - 100km, ø200mm, reflective class 2 foil</i>

**laminiert auf einen Untergrund: / laminated onto a background:**

69.101.79/xx + 31.940.00	Laminiert auf 1mm Aluminium <i>Laminated on 1mm aluminum</i>
69.101.79/xx + 25.940.00	Laminiert auf 1mm Kunststoff <i>Laminated on 1mm plastic</i>

Geschwindigkeit Frankreich / Speedsign France

Art. Nr.	Kennzeichnung: ø200mm - schwarz-weiß - nicht reflektierend Description: ø200mm - black-white - non-reflective	Abbildung / Sample
69.101.72/25	Geschwindigkeit Frankreich, Aufkleber - 25km <i>Speedsign France, sticker - 25km</i>	 <p data-bbox="1267 674 1390 701">ø200mm</p>
69.101.72/30	Geschwindigkeit Frankreich, Aufkleber - 30km <i>Speedsign France, sticker - 30km</i>	
69.101.72/60	Geschwindigkeit Frankreich, Aufkleber - 60km <i>Speedsign France, sticker - 60km</i>	
69.101.72/70	Geschwindigkeit Frankreich, Aufkleber - 70km <i>Speedsign France, sticker - 70km</i>	
69.101.72/80	Geschwindigkeit Frankreich, Aufkleber - 80km <i>Speedsign France, sticker - 80km</i>	
69.101.72/90	Geschwindigkeit Frankreich, Aufkleber - 90km <i>Speedsign France, sticker - 90km</i>	
69.101.72/100	Geschwindigkeit Frankreich, Aufkleber - 100km <i>Speedsign France, sticker - 100km</i>	
69.172.10/25	Satz: 10 stück geschwindigkeit Frankreich, Aufkleber - 25km <i>Set of 10 pieces speedsign France, stickers - 25km</i>	
69.172.10/60	Satz: 10 stück geschwindigkeit Frankreich, Aufkleber - 60km <i>Set of 10 pieces speedsign France, stickers - 60km</i>	
69.172.10/70	Satz: 10 stück geschwindigkeit Frankreich, Aufkleber - 70km <i>Set of 10 pieces speedsign France, stickers - 70km</i>	
69.172.10/80	Satz: 10 stück geschwindigkeit Frankreich, Aufkleber - 80km <i>Set of 10 pieces speedsign France, stickers - 80km</i>	
69.172.10/90	Satz: 10 stück geschwindigkeit Frankreich, Aufkleber - 90km <i>Set of 10 pieces speedsign France, stickers - 90km</i>	
69.172.10/100	Satz: 10 stück geschwindigkeit Frankreich, Aufkleber - 100km <i>Set of 10 pieces speedsign France, stickers - 100km</i>	
69.272.10/25	Satz: 10 stück geschwindigkeit Frankreich, Kunststoff - 25km <i>Set of 10 pieces speedsign France, plastic - 25km</i>	
69.272.10/60	Satz: 10 stück geschwindigkeit Frankreich, Kunststoff - 60km <i>Set of 10 pieces speedsign France, plastic - 60km</i>	
69.272.10/70	Satz: 10 stück geschwindigkeit Frankreich, Kunststoff - 70km <i>Set of 10 pieces speedsign France, plastic - 70km</i>	
69.272.10/80	Satz: 10 stück geschwindigkeit Frankreich, Kunststoff - 80km <i>Set of 10 pieces speedsign France, plastic - 80km</i>	
69.272.10/90	Satz: 10 stück geschwindigkeit Frankreich, Kunststoff - 90km <i>Set of 10 pieces speedsign France, plastic - 90km</i>	
69.272.10/100	Satz: 10 stück geschwindigkeit Frankreich, Kunststoff - 100km <i>Set of 10 pieces speedsign France, plastic - 100km</i>	

Geschwindigkeit Dänemarken - Deutschland / Speedsign Danmark - Germany

Art. Nr.	Kennzeichnung: rot-weiß / Description: red-white	Abbildung / Sample
69.103.75/15	Geschwindigkeit DK - 15km, ø210 mm, reflekt. Typ 1 Folie <i>Speedsign Denmark - 15km, ø210mm, reflective class 1 foil</i>	 <p>ø210mm</p>
69.103.75/45	Geschwindigkeit DK - 45km, ø210 mm, reflekt. Typ 1 Folie <i>Speedsign Denmark - 45km, ø210mm, reflective class 1 foil</i>	
69.103.75/60	Geschwindigkeit DK - 60km, ø210 mm, reflekt. Typ 1 Folie <i>Speedsign Denmark - 60km, ø210mm, reflective class 1 foil</i>	
69.103.75/70	Geschwindigkeit DK - 70km, ø210 mm, reflekt. Typ 1 Folie <i>Speedsign Denmark - 70km, ø210mm, reflective class 1 foil</i>	
69.103.75/80	Geschwindigkeit DK - 80km, ø210 mm, reflekt. Typ 1 Folie <i>Speedsign Denmark - 80km, ø210mm, reflective class 1 foil</i>	

laminiert auf einen Untergrund: / laminated onto a background:

69.103.75.25/60	60km, Laminiert auf 1mm Kunststoff <i>60km, Laminated on 1mm plastic</i>
69.103.75.27/60	60km, Laminiert auf 0,9mm Magnetfolie <i>60km, Laminated on 0,9mm Magnetic foil</i>



69.103.70/60	Geschwindigkeit Deutschland - 60km, ø200 mm, nicht reflekt. Folie <i>Speedsign Germany - 60km, ø200mm, non-reflective foil</i>	 <p>ø200mm</p>
69.103.70/70	Geschwindigkeit Deutschland - 70km, ø200 mm, nicht reflekt. Folie <i>Speedsign Germany - 70km, ø200mm, non-reflective foil</i>	
69.103.70/80	Geschwindigkeit Deutschland - 80km, ø200 mm, nicht reflekt. Folie <i>Speedsign Germany - 80km, ø200mm, non-reflective foil</i>	
69.103.70/90	Geschwindigkeit Deutschland - 90km, ø200 mm, nicht reflekt. Folie <i>Speedsign Germany - 90km, ø200mm, non-reflective foil</i>	
69.103.70/100	Geschwindigkeit Deutschland - 100km, ø200 mm, nicht reflekt. Folie <i>Speedsign Germany - 100km, ø210mm, non-reflective foil</i>	

laminiert auf einen Untergrund: / laminated onto a background:

69.103.70.25/10	10km, Laminiert auf 1mm Kunststoff <i>10km, Laminated on 1mm plastic</i>
69.103.70.25/15	15km, Laminiert auf 1mm Kunststoff <i>15km, Laminated on 1mm plastic</i>
69.103.70.25/60	60km, Laminiert auf 1mm Kunststoff <i>60km, Laminated on 1mm plastic</i>
69.103.70.25/90	90km, Laminiert auf 1mm Kunststoff <i>90km, Laminated on 1mm plastic</i>
69.103.70.27/15	15km, Laminiert auf 10,9mm Magnetfolie <i>15km, Laminated on 0,9mm Magnetic foil</i>



Geschwindigkeit Deutschland / Speedsign Germany

Art. Nr. Kennzeichnung: schwarz-weiß / Description: black-white
 ø200mm nicht reflektierend / ø200mm non-reflective

Abbildung / Sample

69.101.70/6	Geschwindigkeit Deutschland - 6km, Aufkleber Speedsign Germany - 6km, sticker
69.101.70/8	Geschwindigkeit Deutschland - 8km, Aufkleber Speedsign Germany - 8km, sticker
69.101.70/10	Geschwindigkeit Deutschland - 10km, Aufkleber Speedsign Germany - 10km, sticker
69.101.70/16	Geschwindigkeit Deutschland - 16km, Aufkleber Speedsign Germany - 16km, sticker
69.101.70/20	Geschwindigkeit Deutschland - 20km, Aufkleber Speedsign Germany - 20km, sticker
69.101.70/25	Geschwindigkeit Deutschland - 25km, Aufkleber Speedsign Germany - 25km, sticker
69.101.70/30	Geschwindigkeit Deutschland - 30km, Aufkleber Speedsign Germany - 30km, sticker
69.101.70/40	Geschwindigkeit Deutschland - 40km, Aufkleber Speedsign Germany - 40km, sticker
69.101.70/50	Geschwindigkeit Deutschland - 50km, Aufkleber Speedsign Germany - 50km, sticker
69.101.70/60	Geschwindigkeit Deutschland - 60km, Aufkleber Speedsign Germany - 60km, sticker
69.101.70/62	Geschwindigkeit Deutschland - 62km, Aufkleber Speedsign Germany - 62km, sticker
69.101.70/70	Geschwindigkeit Deutschland - 70km, Aufkleber Speedsign Germany - 70km, sticker
69.101.70/80	Geschwindigkeit Deutschland - 80km, Aufkleber Speedsign Germany - 80km, sticker
69.101.70/90	Geschwindigkeit Deutschland - 90km, Aufkleber Speedsign Germany - 90km, sticker
69.101.70/100	Geschwindigkeit Deutschland - 100km, Aufkleber Speedsign Germany - 100km, sticker
69.101.70.25/6	Geschwindigkeit Deutschland - 6km, Kunststoff Speedsign Germany - 6km, plastic
69.101.70.25/20	Geschwindigkeit Deutschland - 20km, Kunststoff Speedsign Germany - 20km, plastic
69.101.70.25/25	Geschwindigkeit Deutschland - 25km, Kunststoff Speedsign Germany - 25km, plastic
69.101.70.25/40	Geschwindigkeit Deutschland - 40km, Kunststoff Speedsign Germany - 40km, plastic
69.101.70.25/50	Geschwindigkeit Deutschland - 50km, Kunststoff Speedsign Germany - 50km, plastic



ø200mm

Geschwindigkeit Deutschland / Speedsign Germany

Art. Nr.	Kennzeichnung: schwarz-weiß / Description: black-white ø200mm nicht reflektierend / ø200mm non-reflective	Abbildung / Sample
69.101.70.25/60	Geschwindigkeit Deutschland - 60km, Kunststoff Speedsign Germany - 60km, plastic	
69.101.70.25/62	Geschwindigkeit Deutschland - 62km, Kunststoff Speedsign Germany - 62km, plastic	
69.101.70.25/80	Geschwindigkeit Deutschland - 80km, Kunststoff Speedsign Germany - 80km, plastic	
69.101.70.31/6	Geschwindigkeit Deutschland - 6km, 1mm Aluminium Speedsign Germany - 6km, 1mm aluminum	
69.101.70.31/20	Geschwindigkeit Deutschland - 20km, 1mm Aluminium Speedsign Germany - 20km, 1mm aluminum	
69.101.70.31/25	Geschwindigkeit Deutschland - 25km, 1mm Aluminium Speedsign Germany - 25km, 1mm aluminum	
69.101.70.31/40	Geschwindigkeit Deutschland - 40km, 1mm Aluminium Speedsign Germany - 40km, 1mm aluminum	
69.101.70.31/50	Geschwindigkeit Deutschland - 50km, 1mm Aluminium Speedsign Germany - 50km, 1mm aluminum	
69.101.70.31/60	Geschwindigkeit Deutschland - 60km, 1mm Aluminium Speedsign Germany - 60km, 1mm aluminum	
69.101.70.31/62	Geschwindigkeit Deutschland - 62km, 1mm Aluminium Speedsign Germany - 62km, 1mm aluminum	
69.101.70.31/80	Geschwindigkeit Deutschland - 80km, 1mm Aluminium Speedsign Germany - 80km, 1mm aluminum	

ø200mm

Geschwindigkeit Deutschland - Europa / Speedsign Germany - Europe

Art. Nr.	Kennzeichnung: rot-weiß / Description: red-white	Abbildung / Sample
69.103.89/15	Geschwindigkeit D/EUR - 15km, ø200 mm, reflekt. Typ 1 Folie <i>Speedsign D/EUR - 15km, ø200mm, reflective class 1 foil</i>	
69.103.89/20	Geschwindigkeit D/EUR - 20km, ø200 mm, reflekt. Typ 1 Folie <i>Speedsign D/EUR - 20km, ø200mm, reflective class 1 foil</i>	
69.103.89/25	Geschwindigkeit D/EUR - 25km, ø200 mm, reflekt. Typ 1 Folie <i>Speedsign D/EUR - 25km, ø200mm, reflective class 1 foil</i>	
69.103.89/30	Geschwindigkeit D/EUR - 30km, ø200 mm, reflekt. Typ 1 Folie <i>Speedsign D/EUR - 30km, ø200mm, reflective class 1 foil</i>	
69.103.89/40	Geschwindigkeit D/EUR - 40km, ø200 mm, reflekt. Typ 1 Folie <i>Speedsign D/EUR - 40km, ø200mm, reflective class 1 foil</i>	
69.103.89/50	Geschwindigkeit D/EUR - 50km, ø200 mm, reflekt. Typ 1 Folie <i>Speedsign D/EUR - 50km, ø200mm, reflective class 1 foil</i>	
69.103.89/60	Geschwindigkeit D/EUR - 60km, ø200 mm, reflekt. Typ 1 Folie <i>Speedsign D/EUR - 60km, ø200mm, reflective class 1 foil</i>	
69.103.89/70	Geschwindigkeit D/EUR - 70km, ø200 mm, reflekt. Typ 1 Folie <i>Speedsign D/EUR - 70km, ø200mm, reflective class 1 foil</i>	
69.103.89/80	Geschwindigkeit D/EUR - 80km, ø200 mm, reflekt. Typ 1 Folie <i>Speedsign D/EUR - 80km, ø200mm, reflective class 1 foil</i>	
69.103.89/90	Geschwindigkeit D/EUR - 90km, ø200 mm, reflekt. Typ 1 Folie <i>Speedsign D/EUR - 90km, ø200mm, reflective class 1 foil</i>	
69.103.89/100	Geschwindigkeit D/EUR - 100km, ø200 mm, reflekt. Typ 1 Folie <i>Speedsign D/EUR - 100km, ø200mm, reflective class 1 foil</i>	
69.103.89/110	Geschwindigkeit D/EUR - 110km, ø200 mm, reflekt. Typ 1 Folie <i>Speedsign D/EUR - 110km, ø200mm, reflective class 1 foil</i>	

laminiert auf einen Untergrund: / laminated onto a background:

69.103.89.25/25	25km, Laminiert auf 1mm Kunststoff <i>25km, Laminated on 1mm plastic</i>
69.103.89.25/40	40km, Laminiert auf 1mm Kunststoff <i>40km, Laminated on 1mm plastic</i>
69.103.89.25/60	60km, Laminiert auf 1mm Kunststoff <i>60km, Laminated on 1mm plastic</i>
69.103.89.31/25	25km, Laminiert auf 1mm Aluminium <i>25km, Laminated on 1mm aluminum</i>
69.103.89.31/40	40km, Laminiert auf 1mm Aluminium <i>40km, Laminated on 1mm aluminum</i>
69.103.89.31/60	60km, Laminiert auf 1mm Aluminium <i>60km, Laminated on 1mm aluminum</i>
69.103.89.27/50	50km, Laminiert auf 0,9mm Magnetfolie <i>50km, Laminated on 0,9mm Magnetic foil</i>
69.103.89.27/60	60km, Laminiert auf 0,9mm Magnetfolie <i>60km, Laminated on 0,9mm Magnetic foil</i>



Industrielle selbstklebende Rollen / *industrial adhesive rolls*

Art. Nr. Kennzeichnung / *Description*
 schraffiert, 70mm senkrecht / *shaped, perpendicular 70mm*

Abbildung / *Sample*Industrielle Folie, reflektierend Typ 1 / *Industrial foil, reflective class 1*Typ 1 50mm Rolle / *Class 1 50mm roll*

81.163.10L	Rolle rot/weiß, linksweisend 50mmx10M <i>Roll red/white, leftsided 50mmx10M</i>
81.163.10R	Rolle rot/weiß, rechtsweisend 50mmx10M <i>Roll red/white, rightsided 50mmx10M</i>
81.163.23.0L	Rolle rot/weiß, linksweisend 50mmx25M <i>Roll red/white, leftsided 50mmx25M</i>
81.163.23.0R	Rolle rot/weiß, rechtsweisend 50mmx25M <i>Roll red/white, rightsided 50mmx25M</i>
81.163.45.0L	Rolle rot/weiß, linksweisend 50mmx50M <i>Roll red/white, leftsided 50mmx50M</i>
81.163.45.0R	Rolle rot/weiß, rechtsweisend 50mmx50M <i>Roll red/white, rightsided 50mmx50M</i>

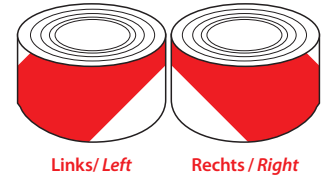
Industrielle Folie reflektierend Typ 1 / *Industrial foil, reflective class 1*Typ 1 100mm Rolle / *Class 1 100mm roll*

81.145.0L	Rolle gelb/schwarz, linksweisend 100mmx10M <i>Roll yellow/black, leftsided 100mmx10M</i>
81.145.0R	Rolle gelb/schwarz, rechtsweisend 100mmx10M <i>Roll yellow/black, rightsided 100mmx10M</i>
81.145.45.0L	Rolle gelb/schwarz, linksweisend 100mmx50M <i>Roll yellow/black, leftsided 100mmx50M</i>
81.145.45.0R	Rolle gelb/schwarz, rechtsweisend 100mmx50M <i>Roll yellow/black, rightsided 100mmx50M</i>

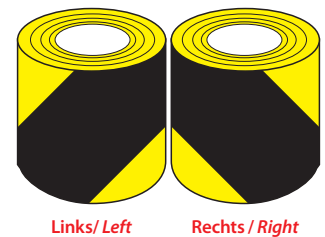
Industrielle Folie reflektierend Typ 1 / *Industrial foil, reflective class 1*Typ 1 50mm Rolle / *Class 1 50mm roll*

81.165.0L	Rolle gelb/schwarz, linksweisend 50mmx10M <i>Roll yellow/black, leftsided 50mmx10M</i>
81.165.0R	Rolle gelb/schwarz, rechtsweisend 50mmx10M <i>Roll yellow/black, rightsided 50mmx10M</i>
81.165.45.0L	Rolle gelb/schwarz, linksweisend 50mmx50M <i>Roll yellow/black, leftsided 50mmx50M</i>
81.165.45.0R	Rolle gelb/schwarz, rechtsweisend 50mmx50M <i>Roll yellow/black, rightsided 50mmx50M</i>

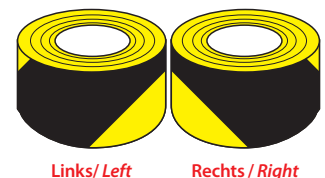

Selbstklebend, dauerhaft / Self adhesive, durable

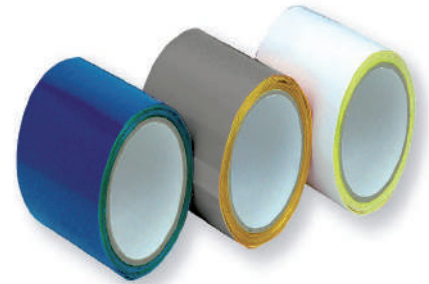

Art. Nr.

Kennzeichnung / Description

Farbe / Color

Art. Nr.	Kennzeichnung / Description	Farbe / Color
	50mmx5M	
82.901.00	Rolle Planenreparatur, 50mmx5M, RAL <i>Tarpaulin repair roll, 50mmx5M, RAL</i>	schwarz / black
82.902.00	Rolle Planenreparatur, 50mmx5M, RAL <i>Tarpaulin repair roll, 50mmx5M, RAL</i>	orange / orange
82.903.00	Rolle Planenreparatur, 50mmx5M, RAL <i>Tarpaulin repair roll, 50mmx5M, RAL</i>	silber / silver
82.904.00	Rolle Planenreparatur, 50mmx5M, RAL <i>Tarpaulin repair roll, 50mmx5M, RAL</i>	hellgrau / light grey
82.905.00	Rolle Planenreparatur, 50mmx5M, RAL <i>Tarpaulin repair roll, 50mmx5M, RAL</i>	rot / red
82.906.00	Rolle Planenreparatur, 50mmx5M, RAL <i>Tarpaulin repair roll, 50mmx5M, RAL</i>	gelb / yellow
82.907.00	Rolle Planenreparatur, 50mmx5M, RAL <i>Tarpaulin repair roll, 50mmx5M, RAL</i>	dunkelgrün / dark green
82.908.00	Rolle Planenreparatur, 50mmx5M, RAL <i>Tarpaulin repair roll, 50mmx5M, RAL</i>	weiss / white
82.909.00	Rolle Planenreparatur, 50mmx5M, RAL <i>Tarpaulin repair roll, 50mmx5M, RAL</i>	blau / blue
	100mmx5M	
82.911.00	Rolle Planenreparatur, 100mmx5M, RAL <i>Tarpaulin repair roll, 100mmx5M, RAL</i>	schwarz / black
82.912.00	Rolle Planenreparatur, 100mmx5M, RAL <i>Tarpaulin repair roll, 100mmx5M, RAL</i>	orange / orange
82.913.00	Rolle Planenreparatur, 100mmx5M, RAL <i>Tarpaulin repair roll, 100mmx5M, RAL</i>	silber / silver
82.914.00	Rolle Planenreparatur, 100mmx5M, RAL <i>Tarpaulin repair roll, 100mmx5M, RAL</i>	hellgrau / light grey
82.915.00	Rolle Planenreparatur, 100mmx5M, RAL <i>Tarpaulin repair roll, 100mmx5M, RAL</i>	rot / red
82.916.00	Rolle Planenreparatur, 100mmx5M, RAL <i>Tarpaulin repair roll, 100mmx5M, RAL</i>	gelb / yellow
82.917.00	Rolle Planenreparatur, 100mmx5M, RAL <i>Tarpaulin repair roll, 100mmx5M, RAL</i>	dunkelgrün / dark green
82.918.00	Rolle Planenreparatur, 100mmx5M, RAL <i>Tarpaulin repair roll, 100mmx5M, RAL</i>	weiss / white
82.919.00	Rolle Planenreparatur, 100mmx5M, RAL <i>Tarpaulin repair roll, 100mmx5M, RAL</i>	blau / blue

Niederlande, Belgien, allgemein / Netherlands, Belgium, in general

Art. Nr.	Kennzeichnung / Description	Abbildung / Sample
29.487.00	TRANSPORT EXCEPTIONNEL 1000x160mm, Aufkleber <i>TRANSPORT EXCEPTIONNEL 1000x160mm, sticker</i>	UITZONDERLIJK VERVOER
29.488.00	UITZONDERLIJK VERVOER 1000x160mm, Aufkleber <i>UITZONDERLIJK VERVOER 1000x160mm, sticker</i>	TRANSPORT EXCEPTIONNEL
29.489.00	CONVOI EXCEPTIONNEL 1000x160mm, Aufkleber <i>CONVOI EXCEPTIONNEL 1000x160mm, sticker</i>	CONVOI EXCEPTIONNEL
29.488.27	UITZONDERLIJK VERVOER 1000x160x0,9mm, magnetfolie <i>UITZONDERLIJK VERVOER 1000x160x0,9mm, magnetic foil</i>	 Reflektierend gelb Typ 1 <i>Reflective yellow class 1</i>
29.588.00	UITZONDERLIJK VERVOER 1000x160mm, Aufkleber <i>UITZONDERLIJK VERVOER 1000x160mm, sticker</i>	UITZONDERLIJK VERVOER
29.589.00	CONVOI EXCEPTIONNEL 1000x160mm, Aufkleber <i>CONVOI EXCEPTIONNEL 1000x160mm, sticker</i>	CONVOI EXCEPTIONNEL
		Rot fluoreszierend <i>Red fluorescent</i>
29.487.00 + 31.935.00	TRANSPORT EXCEPTIONNEL 1000x160mm, laminiert auf 1mm Alu <i>TRANSPORT EXCEPTIONNEL 1000x160mm, laminated on 1mm alu</i>	UITZONDERLIJK VERVOER
29.488.00 + 31.935.00	UITZONDERLIJK VERVOER 1000x160mm, laminiert auf 1mm Alu <i>UITZONDERLIJK VERVOER 1000x160mm, laminated on 1mm alu</i>	TRANSPORT EXCEPTIONNEL
29.489.00 + 31.935.00	CONVOI EXCEPTIONNEL 1000x160mm, laminiert auf 1mm Alu <i>CONVOI EXCEPTIONNEL 1000x160mm, laminated on 1mm alu</i>	CONVOI EXCEPTIONNEL
		EINSEITIG, Reflektierend gelb Typ 1 <i>SINGLESIDED, Reflective yellow class 1</i>
29.588.00 + 31.935.00	UITZONDERLIJK VERVOER 1000x160mm, laminiert auf 1mm Alu <i>UITZONDERLIJK VERVOER 1000x160mm, laminated on 1mm alu</i>	UITZONDERLIJK VERVOER
29.589.00 + 31.935.00	CONVOI EXCEPTIONNEL 1000x160mm, laminiert auf 1mm Alu <i>CONVOI EXCEPTIONNEL 1000x160mm, laminated on 1mm alu</i>	CONVOI EXCEPTIONNEL
		EINSEITIG, Rot fluoreszierend <i>SINGLESIDED, Red fluorescent</i>
29.487.00 + 32.935.00	TRANSPORT EXCEPTIONNEL 1000x160mm, laminiert auf 2mm Alu <i>TRANSPORT EXCEPTIONNEL 1000x160mm, laminated on 2mm alu</i>	UITZONDERLIJK VERVOER
29.488.00 + 32.935.00	UITZONDERLIJK VERVOER 1000x160mm, laminiert auf 2mm Alu <i>UITZONDERLIJK VERVOER 1000x160mm, laminated on 2mm alu</i>	TRANSPORT EXCEPTIONNEL
29.489.00 + 32.935.00	CONVOI EXCEPTIONNEL 1000x160mm, laminiert auf 2mm Alu <i>CONVOI EXCEPTIONNEL 1000x160mm, laminated on 2mm alu</i>	CONVOI EXCEPTIONNEL
		EINSEITIG, Reflektierend gelb Typ 1 <i>SINGLESIDED, Reflective yellow class 1</i>

Niederlande, Belgien, allgemein / Netherlands, Belgium, in general

Art. Nr.	Kennzeichnung / Description Reflektierend gelb Typ 1 / Reflective yellow class 1	Abbildung / Sample
29.490.00	TRANSPORT EXCEPTIONNEL 1250x250mm, Aufkleber <i>TRANSPORT EXCEPTIONNEL 1250x250mm, sticker</i>	
29.491.00	UITZONDERLIJK VERVOER 1250x250mm, Aufkleber <i>UITZONDERLIJK VERVOER 1250x250mm, sticker</i>	
29.492.00	CONVOI EXCEPTIONNEL 1250x250mm, Aufkleber <i>CONVOI EXCEPTIONNEL 1250x250mm, sticker</i>	
29.493.00	SCHWERTRANSPORT 1250x250mm, Aufkleber <i>SCHWERTRANSPORT 1250x250mm, sticker</i>	
29.494.00	TRANSPORT EXCEPTIONNEL + UITZONDERLIJK VERVOER 1250x300mm, Aufkleber <i>TRANSPORT EXCEPTIONNEL + UITZONDERLIJK VERVOER 1250x300mm, sticker</i>	
29.496.00	TRANSPORT EXCEPTIONNEL + SCHWERTRANSPORT 1250x300mm, Aufkleber <i>TRANSPORT EXCEPTIONNEL + SCHWERTRANSPORT 1250x300mm, sticker</i>	 <small>Reflektierend gelb Typ 1 Reflective yellow class 1</small>
29.490.00 + 31.936.00	TRANSPORT EXCEPTIONNEL 1250x250mm, laminiert auf 1mm Alu <i>TRANSPORT EXCEPTIONNEL 1250x250mm, laminated on 1mm alu</i>	
29.491.00 + 31.936.00	UITZONDERLIJK VERVOER 1250x250mm, laminiert auf 1mm Alu <i>UITZONDERLIJK VERVOER 1250x250mm, laminated on 1mm alu</i>	
29.492.00 + 31.936.00	CONVOI EXCEPTIONNEL 1250x250mm, laminiert auf 1mm Alu <i>CONVOI EXCEPTIONNEL 1250x250mm, laminated on 1mm alu</i>	
29.493.00 + 31.936.00	SCHWERTRANSPORT 1250x250mm, laminiert auf 1mm Alu <i>SCHWERTRANSPORT 1250x250mm, laminated on 1mm alu</i>	 <small>EINSEITIG, Reflektierend gelb Typ 1 SINGLESIDED, Reflective yellow class 1</small>
29.490.00 + 32.936.00	TRANSPORT EXCEPTIONNEL 1250x250mm, laminiert auf 2mm Alu <i>TRANSPORT EXCEPTIONNEL 1250x250mm, laminated on 2mm alu</i>	
29.491.00 + 32.936.00	UITZONDERLIJK VERVOER 1250x250mm, laminiert auf 2mm Alu <i>UITZONDERLIJK VERVOER 1250x250mm, laminated on 2mm alu</i>	
29.492.00 + 32.936.00	CONVOI EXCEPTIONNEL 1250x250mm, laminiert auf 2mm Alu <i>CONVOI EXCEPTIONNEL 1250x250mm, laminated on 2mm alu</i>	
29.493.00 + 32.936.00	SCHWERTRANSPORT 1250x250mm, laminiert auf 2mm Alu <i>SCHWERTRANSPORT 1250x250mm, laminated on 2mm alu</i>	 <small>EINSEITIG, Reflektierend gelb Typ 1 SINGLESIDED, Reflective yellow class 1</small>

Niederlande, Belgien, Frankreich, allgemein / Netherlands, Belgium, France, in general

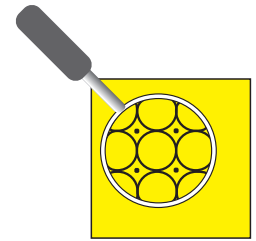
CONVOI EXCEPTIONNEL**UITZONDERLIJK VERVOER****TRANSPORT EXCEPTIONNEL****CONVOI
EXCEPTIONNEL**

Art. Nr.	Kennzeichnung / Description Reflektierend gelb Typ 2 / Reflective yellow class 2	Abbildung / Sample
29.463.32	TRANSPORT EXCEPTIONNEL, einseitig, 2 zeilig, 1200x400mm, laminiert auf 2mm Aluminium <i>TRANSPORT EXCEPTIONNEL, singlesided, 2 line, 1200x400mm, laminated on 2mm aluminum</i>	
29.467.32	UITZONDERLIJK VERVOER, einseitig, 1 zeilig, 1900x250mm, laminiert auf 2mm Aluminium <i>UITZONDERLIJK VERVOER, singlesided, 1 line, 1900x250mm, laminated on 2mm aluminum</i>	
29.468.32	CONVOI EXCEPTIONNEL, einseitig, 1 zeilig, 2300x250mm, laminiert auf 2mm Aluminium <i>CONVOI EXCEPTIONNEL, singlesided, 1 line, 2300x250mm, laminated on 2mm aluminum</i>	
29.477.32	CONVOI EXCEPTIONNEL (F), einseitig, 1 zeilig, 1900x250mm, laminiert auf 2mm Aluminium <i>CONVOI EXCEPTIONNEL (F), singlesided, 1 line, 1900x250mm, laminated on 2mm aluminum</i>	
29.478.32	CONVOI EXCEPTIONNEL (F), einseitig, 2 zeilig, 1200x400mm, laminiert auf 2mm Aluminium <i>CONVOI EXCEPTIONNEL (F), singlesided, 2 line, 1200x400mm, laminated on 2mm aluminum</i>	
29.464.32	CONVOI EXCEPTIONNEL / TRANSPORT EXCEPTIONNEL beidseitig, je 2 zeilig, 1200x400mm, laminiert auf 2mm Aluminium <i>CONVOI EXCEPTIONNEL / TRANSPORT EXCEPTIONNEL doublesided, both 2 line, 1200x400mm, laminated on 2mm aluminum</i>	
29.469.32	CONVOI EXCEPTIONNEL / UITZONDERLIJK VERVOER beidseitig, je 1 zeilig, 1900x250mm, laminiert auf 2mm Aluminium <i>CONVOI EXCEPTIONNEL / UITZONDERLIJK VERVOER doublesided, both 1 line, 1900x250mm, laminated on 2mm aluminum</i>	
29.476.32	CONVOI EXCEPTIONNEL / UITZONDERLIJK VERVOER beidseitig, je 2 zeilig, 1200x400mm, laminiert auf 2mm Aluminium <i>CONVOI EXCEPTIONNEL / UITZONDERLIJK VERVOER doublesided, both 2 line, 1200x400mm, laminated on 2mm aluminum</i>	
29.479.32	CONVOI EXCEPTIONNEL / CONVOI EXCEPTIONNEL (2x) beidseitig, je 2 zeilig, 1200x400mm, laminiert auf 2mm Aluminium <i>CONVOI EXCEPTIONNEL / CONVOI EXCEPTIONNEL (2x) doublesided, both 2 line, 1200x400mm, laminated on 2mm aluminum</i>	
29.486.32	CONVOI EXCEPTIONNEL / TRANSPORT EXCEPTIONNEL beidseitig, je 1 zeilig, 1900x250mm, laminiert auf 2mm Aluminium <i>CONVOI EXCEPTIONNEL / TRANSPORT EXCEPTIONNEL doublesided, both 1 line, 1900x250mm, laminated on 2mm aluminum</i>	

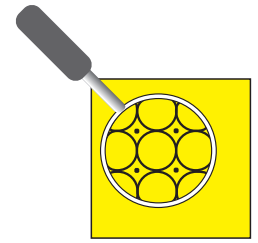

CONVOI AGRICOLE**CONVOI
AGRICOLE**

29.487.33	CONVOI AGRICOLE (F), einseitig, 1 zeilig, 1900x250mm, laminiert auf 1mm Stahlblech <i>CONVOI AGRICOLE (F), singlesided, 1 line, 1900x250mm, laminated on 1mm steel</i>
29.488.33	CONVOI AGRICOLE (F), einseitig, 2 zeilig, 1200x400mm, laminiert auf 1mm Stahlblech <i>CONVOI AGRICOLE (F), singlesided, 2 line, 1200x400mm, laminated on 1mm steel</i>



Niederlande, Belgien, Frankreich, allgemein / *Netherlands, Belgium, France, in general*



Art. Nr.	Kennzeichnung / <i>Description</i> Planenfolie, Reflektierend Typ 2 / <i>Reflective class 2 tarpaulin foil</i>	Abbildung / <i>Sample</i>
29.700.00	UITZONDERLIJK VERVOER, 2 zeilig, 1200x400mm <i>UITZONDERLIJK VERVOER, 2 line, 1200x400mm</i>	
29.710.00	UITZONDERLIJK VERVOER, 1 zeilig, 1900x250mm <i>UITZONDERLIJK VERVOER, 1 line, 1900x250mm</i>	
29.720.00	UITZONDERLIJK VERVOER, 1 zeilig, 1250x250mm <i>UITZONDERLIJK VERVOER, 1 line, 1250x250mm</i>	
29.730.00	UITZONDERLIJK VERVOERL, 1 zeilig, 1000x160mm <i>UITZONDERLIJK VERVOER, 1 line, 1000x160mm</i>	
29.701.00	CONVOI EXCEPTIONNEL, 2 zeilig, 1200x400mm <i>CONVOI EXCEPTIONNEL, 2 line, 1200x400mm</i>	
29.711.00	CONVOI EXCEPTIONNEL, 1 zeilig, 1900x250mm <i>CONVOI EXCEPTIONNEL, 1 line, 1900x250mm</i>	
29.721.00	CONVOI EXCEPTIONNEL, 1 zeilig, 1250x250mm <i>CONVOI EXCEPTIONNEL, 1 line, 1250x250mm</i>	
29.731.00	CONVOI EXCEPTIONNEL, 1 zeilig, 1000x160mm <i>CONVOI EXCEPTIONNEL, 1 line, 1000x160mm</i>	
29.702.00	TRANSPORT EXCEPTIONNEL, 2 zeilig, 1200x400mm <i>TRANSPORT EXCEPTIONNEL, 2 line, 1200x400mm</i>	
29.712.00	TRANSPORT EXCEPTIONNEL, 1 zeilig, 1900x250mm <i>TRANSPORT EXCEPTIONNEL, 1 line, 1900x250mm</i>	
29.722.00	TRANSPORTEEXCEPTIONNEL, 1 zeilig, 1250x250mm <i>TRANSPORT EXCEPTIONNEL, 1 line, 1250x250mm</i>	
29.732.00	TRANSPORT EXCEPTIONNEL, 1 zeilig, 1000x160mm <i>TRANSPORT EXCEPTIONNEL, 1 line, 1000x160mm</i>	
29.799.00	Befestigungssatz für Planenfolie: 4x Gummi + 4x Ösen <i>Mountingset for tarpaulin foil: 4x rubber + 4x S-hook</i>	

Niederlande, Deutschland, Italien / Netherlands, Germany, Italy

Art. Nr.	Kennzeichnung / Description	Abbildung / Sample
36.593.00	TRASPORTO ECCEZIONALE, 1 zeilig, 600x150mm Aufkleber gelb Typ 2 <i>TRASPORTO ECCEZIONALE, 1 line, 600x150mm sticker yellow class 2</i>	
36.588.00	TRASPORTO ECCEZIONALE, einseitig, 1 zeilig, 600x150mm Typ 2 laminiert auf 2mm Aluminium <i>TRASPORTO ECCEZIONALE, singlesided, 1 line, 600x150mm, yellow class 2 lam. on 2mm alu</i>	
36.589.00	TRASPORTO ECCEZIONALE, einseitig, 1 zeilig, 1200x250mm, gelb Typ 2 lam. auf 2mm Alu <i>TRASPORTO ECCEZIONALE, singlesided, 1 line, 1200x250mm, yellow class 2 lam. on 2mm alu</i>	
36.591.00	TRASPORTO ECCEZIONALE, einseitig, 2 zeilig, 900x400mm, gelb Typ 2 lam. auf 2mm Alu <i>TRASPORTO ECCEZIONALE, singlesided, 2 line, 900x400mm, yellow class 2 lam. on 2mm alu</i>	
36.590.00	TRASPORTO ECCEZIONALE, beidseitig, 1 zeilig, 1200x250mm, gelb Typ 2 lam. auf 2mm Alu <i>TRASPORTO ECCEZIONALE, doublesided, 1 line, 1200x250mm, yellow class 2 lam. on 2mm alu</i>	

Art.1 Vv 29.4.2016 Banz At 09.05.2016. §5/#13. Rückwertige Kenntlichmachung durch ein Schild aus retroreflektierendem Material der UN/ECE70/ECE48 Typegenehmigung (BGBl.1994 II S.970)

36.674.00	Nach ECE 70-01 Norm auf 2mm Aluminium LANG-LKW, einseitig, 1 zeilig, 1150x280x2mm, gelb Typ 3 <i>LANG-LKW, singlesided, 1 line, 1150x280x2mm, yellow class 3</i>	
36.679.00	LANG-LKW, einseitig, 1 zeilig, 770x230x2mm, gelb Typ 3 <i>LANG-LKW, singlesided, 1 line, 770x230x2mm, yellow class 3</i>	
36.680.00	LANG-LKW, einseitig, 2 zeilig, 400x400x2mm, gelb Typ 3 <i>LANG-LKW, singlesided, 2 line, 400x400x2mm, yellow class 3</i>	
36.674.00	LANG-LKW, einseitig, 1 zeilig, 1150x280x2mm, gelb Typ 3 <i>LANG-LKW, singlesided, 1 line, 1150x280x2mm, yellow class 3</i>	 Schrifthöhe 130mm
36.674.27	Nach ECE 70-01 Norm auf 0,9mm Magnetfolie LANG-LKW, 1 zeilig, 1150x280x0,9mm, gelb Typ 3 <i>LANG-LKW, 1 line, 1150x280x0,9mm, yellow class 3</i>	

36.430.00	Nach ECE 70 Norm auf 2mm Aluminium LET OP! EXTRA LANG, 1132x197x2mm, gelb Typ 2 <i>LET OP! EXTRA LANG, 1132x197x2mm, yellow class 2</i>	
36.431.00	LET OP!, 566x197x2mm, gelb Typ 2 <i>LET OP!, 566x197x2mm, yellow class 2</i>	
36.432.00	EXTRA LANG, 566x197x2mm, gelb Typ 2 <i>EXTRA LANG, 566x197x2mm, yellow class 2</i>	
36.439.00	EXTRA LONG, 566x197x2mm, gelb Typ 2 <i>EXTRA LONG, 566x197x2mm, yellow class 2</i>	 Schrifthöhe 80mm

Nicht reflektierend / non-reflective markers

Art. Nr.	Kennzeichnung / Description	Abbildung / Sample
68.050.00	Rot-schwarz 800x200mm / Red-black 800x200mm Achtung Überlänge, selbstklebend <i>Achtung Überlänge, sticker</i>	
68.350.00	Achtung Überlänge, 1mm Stahlblech <i>Achtung Überlänge, 1mm steel</i>	
68.052.00	Achtung Fahrzeug schwenkt aus, selbstklebend <i>Achtung Fahrzeug schwenkt aus, sticker</i>	
68.352.00	Achtung Fahrzeug schwenkt aus, 1mm Stahlblech <i>Achtung Fahrzeug schwenkt aus, 1mm steel</i>	
68.053.00	Achtung Auflieger schwenkt aus, selbstklebend <i>Achtung Auflieger schwenkt aus, sticker</i>	
68.053.26	Achtung Auflieger schwenkt aus, 2mm Kunststoff <i>Achtung Auflieger schwenkt aus, 2mm plastic</i>	
68.353.00	Achtung Auflieger schwenkt aus, 1mm Stahlblech <i>Achtung Auflieger schwenkt aus, 1mm steel</i>	
68.054.00	Achtung Überbreite, selbstklebend <i>Achtung Überbreite, sticker</i>	
68.354.00	Achtung Überbreite, 1mm Stahlblech <i>Achtung Überbreite, 1mm steel</i>	
68.057.00	Achtung Anhänger schert aus, selbstklebend <i>Achtung Anhänger schert aus, sticker</i>	
68.357.00	Achtung Anhänger schert aus, 1mm Stahlblech <i>Achtung Anhänger schert aus, 1mm steel</i>	
68.058.00	Achtung Ladung schwenkt aus, selbstklebend <i>Achtung Ladung schwenkt aus, sticker</i>	
68.358.00	Achtung Ladung schwenkt aus, 1mm Stahlblech <i>Achtung Ladung schwenkt aus, 1mm steel</i>	
68.056.00	Rot-schwarz 650x200mm / Red-black 650x200mm Baustellenfahrzeug, selbstklebend <i>Baustellenfahrzeug, sticker</i>	
68.056.26	Baustellenfahrzeug, 2mm Kunststoff <i>Baustellenfahrzeug, 2mm plastic</i>	
68.356.00	Baustellenfahrzeug, 1mm Stahlblech <i>Baustellenfahrzeug, 1mm steel</i>	

Skandinavien / Scandinavia

Art. Nr.	Kennzeichnung / Description	Abbildung / Sample
----------	-----------------------------	--------------------

36.554.00	Gelb Typ 1 + fluoreszierend rot / Yellow class 1 + fluorescent red Bred Last, 1280x410x2mm Aluminium <i>Bred Last, 1280x410x2mm aluminum</i>	 
36.557.00	Bred Last, 1250x400x2mm Aluminium <i>Bred Last, 1250x400x2mm aluminum</i>	
36.550.00	Bred Last, 640x620x2mm Aluminium <i>Bred Last, 640x620x2mm aluminum</i>	
36.552.00	Bred Last, 900x300x2mm Aluminium <i>Bred Last, 900x300x2mm aluminum</i>	
36.556.00	Bred Last, 565x200x2mm Aluminium <i>Bred Last, 565x200x2mm aluminum</i>	

36.562.00	Klappbar, Gelb Typ 1 + fluoreszierend rot / Foldable, Yellow class 1 + fluorescent red Bred Last, 640x620x2mm, horizontal klappbar, Aluminium <i>Bred Last, 640x620x2mm, horizontally foldable, aluminum</i>
36.563.00	Bred Last, 900x300x2mm, horizontal klappbar, Aluminium <i>Bred Last, 900x300x2mm, horizontally foldable, aluminum</i>
36.567.00	Bred Last, 1250x400x2mm, horizontal klappbar, Aluminium <i>Bred Last, 1250x400x2mm, horizontally foldable, aluminum</i>

50.270.00	Weiß Typ 1 + fluoreszierend rot / White class 1 + fluorescent red Sidomarkierung, vänster, vertikal rechts, 700x200x2mm Aluminium <i>Sidomarking, vänster, vertically right, 700x200x2mm, aluminum</i>	 Höger Vänster
50.271.00	Sidomarkierung, Höger, vertikal links, 700x200x2mm Aluminium <i>Sidomarking, Höger, vertically left, 700x200x2mm, aluminum</i>	
50.276.00	Satz Sidomarkierung, vertikal links + rechts, 700x200x2mm Aluminium <i>Set sidomarking, vertically left + right, 700x200x2mm, aluminum</i>	



36.571.00	Gelb Typ 1 + fluoreszierend rot / Yellow class 1 + fluorescent red Lang Last Dänemark, 900x300x2mm Aluminium <i>Lang Last Denmark, 900x300x2mm aluminum</i>	
36.572.00	Lång Last Sweden, 1200x400x2mm Aluminium <i>Lång Last Sweden, 1200x400x2mm aluminum</i>	

36.566.00	Gelb Typ 1 + fluoreszierend rot / Yellow class 1 + fluorescent red Varning, 1000x400x2mm, beidseitig laminiert auf Aluminium <i>Varning, 1000x400x2mm, doublesided laminated on aluminum</i>	
-----------	---	---

Skandinavien / Scandinavia

Art. Nr.	Kennzeichnung / Description	Abbildung / Sample
36.582.00	Gelb Typ 1 + fluoreszierend rot / Yellow class 1 + fluorescent red Saertransport, 900x300x2mm Aluminium <i>Saertransport, 900x300x2mm aluminum</i>	
36.582.27	Saertransport, 900x300x0,9mm Magnetfolie <i>Saertransport, 900x300x0,9mm magnetic foil</i>	
36.563.00	Saertransport, 900x300x2mm, horizontal klappbar, Aluminium <i>Saertransport, 900x300x2mm, horizontally foldable, aluminum</i>	
36.586.00	Saertransport, 565x200x2mm Aluminium <i>Saertransport, 565x200x2mm aluminum</i>	
36.478.00	Gelb Typ 1 + fluoreszierend rot / Yellow class 1 + fluorescent red Chevrontafel Norwegen, horizontal links, 525x250x2mm Alu <i>Chevronpanel Norway, horizontally left, 525x250x2mm alu</i>	
36.479.00	Chevrontafel Norwegen, horizontal rechts, 525x250x2mm Alu <i>Chevronpanel Norway, horizontally right, 525x250x2mm alu</i>	
36.477.00	Satz Chevrontafeln, horizontal links + rechts, 525x250x2mm Alu <i>Set chevronpanels Norway, horizontally left + right, 525x250x2mm alu</i>	
36.660.00	Weiß Typ 1 + fluoreszierend rot / White class 1 + fluorescent red Bred Transport, 1250x250x2mm Aluminium <i>Bred Transport, 1250x250x2mm Aluminum</i>	
36.661.00	Lang Transport, 1250x250x2mm Aluminium <i>Lang Transport, 1250x250x2mm Aluminum</i>	
36.662.00	Bred Transport Folger, 1250x300x2mm Aluminium <i>Bred Transport Folger, 1250x300x2mm Aluminum</i>	
36.678.00	Weiß + rot Typ 1 / White + red class 1 Tung Last, 850x197x2mm Aluminium <i>Tung Last, 850x197x2mm Aluminum</i>	
36.677.00	Bred Last, 850x197x2mm Aluminium <i>Bred Last, 850x197x2mm Aluminum</i>	
36.676.00	Lang Last, 850x197x2mm Aluminium <i>Lang Last, 850x197x2mm Aluminum</i>	
36.474.00	Weiß + rot Typ 1 / White + red class 1 Eco-Kombi Tafel 25,25m, 1000x500x2mm Aluminium <i>Eco-Kombi sign 25,25m, 1000x500x2mm Aluminum</i>	
36.470.00	Eco-Kombi Tafel 24m, 700x300x2mm Aluminium <i>Eco-Kombi sign 24m, 700x300x2mm Aluminum</i>	
36.471.00	Eco-Kombi Tafel 22m, 700x300x2mm Aluminium <i>Eco-Kombi sign 22m Last, 700x300x2mm Aluminum</i>	

Diverse / Miscellaneous

Art. Nr.	Kennzeichnung / Description	Abbildung / Sample
10.524.00	Niederlande, weiß + rot / Netherlands, white + red Pas op! Zwenkt uit, 920x210x1mm Aluminium <i>Pas op! Zwenkt uit, 920x210x1mm Aluminum</i>	
50.179.00	Österreich, weiß Typ 1 + rot Typ 1 Austria, white class 1 + red class 1 Langguttafel, 400x250x1mm Aluminium mit 2 Löcher <i>Bred Transport, 400x250x1mm Aluminum with 2 holes</i>	
68.040.00	Österreich, weiß Typ 1 / Austria, white class 1 Wagen schert aus, 390x100mm Aufkleber <i>Lang Transport, 390x100mm sticker</i>	
auf Anfrage	Deutschland, reflektierend / Germany, reflective Schwertransport, 1160x300x2mm Aluminium, Typ 1 <i>Schwertransport, 1160x300x2mm Aluminum, class 1</i>	
auf Anfrage	Schwertransport, 840x460x2mm Aluminium, Typ 2 <i>Schwertransport, 840x460x2mm Aluminum, class 2</i>	
50.831.00	Überbreite Tafel LED, rote Positionslampe, mit 5M offene Kabel Oversize panel LED, red positionlight, with 5M cable Überbreite Tafel nach DIN30710, 423x423x1mm Stahlblech, Typ 2 mit roter Positionslampe <i>Oversize panel, 423x423x1mm, according to DIN30710, steel, class 2, with red LED positionlamp</i>	
35.910.00	Halterungen mit Clip / Plateholder with clip Halterung mit 2 Clips, 500x500x0,8mm Edelstahl <i>Plateholder with 2 clips, 500x500x0,8mm stainless steel</i>	
35.914.00	Halterung mit 1 Clip, 1250x250x0,8mm Edelstahl <i>Plateholder with 1 clip, 1250x250x0,8mm stainless steel</i>	
35.915.00	Halterung mit 1 Clip, 1132x197x0,8mm Edelstahl <i>Plateholder with 1 clip, 1132x197x0,8mm stainless steel</i>	
35.916.00	Halterung mit 1 Clip, 1000x160x0,8mm Edelstahl <i>Plateholder with 1 clip, 1000x160x0,8mm stainless steel</i>	
35.918.00	Halterung mit 1 Clip, 566x197x0,8mm Edelstahl <i>Plateholder with 1 clip, 566x197x0,8mm stainless steel</i>	

Diverse / Miscellaneous



Art. Nr.

Kennzeichnung / Description

Abbildung / Sample

51.560.00

Überlänge Tafel, 500x500x3mm Kunststoff (Forex),
Folie nach R86-01-ECE104-F
*Oversize panel, 500x500x3mm Plastic (Forex),
conform ECE70-class 5 / ECE 104-class F*



51.561.00

Überlänge Tafel mit Text, 500x500x3mm Kunststoff (Forex),
Folie nach R86-01-ECE104-F
*Oversize panel with text, 500x500x3mm Plastic (Forex),
conform ECE70-class 5 / ECE 104-class F*



51.398.00

Überlänge Tafel horizontal links, 564x282x1mm Stahlblech,
nach R86-01-ECE104-F
*Oversize panel horizontally left, 564x282x1mm steel,
conform ECE70-class 5 / ECE 104-class F*



51.397.00

Überlänge Tafel horizontal rechts, 564x282x1mm Stahlblech,
nach R86-01-ECE104-F
*Oversize panel horizontally right, 564x282x1mm steel,
conform ECE70-class 5 / ECE 104-class F*



Diverse / miscellaneous... (Type- Chassis ID / Aufkleber / eloxiertes Aluminium)

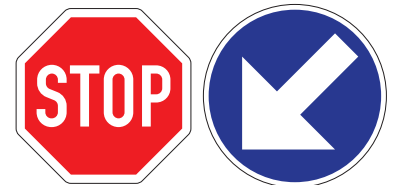
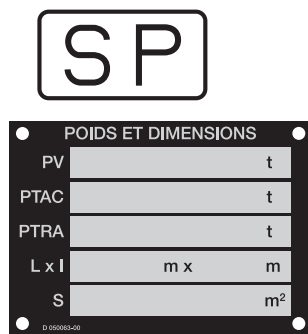

Information

Konturmarkierungen für schwere und lange NFZ/LKW und Anhänger
 StVZO §53, Absatz 10 fordert gelbe oder weiße Konturmarkierungen an der Seite und gelbe oder rote Konturmarkierungen am Heck.

ECE R48- Abschnitt 6.21: regelt wo Konturmarkierung notwendig, erlaubt oder wo ECE 104-C Konturmarkierungen verboten ist.
 Verpflichtend für Nfz $\geq 7,5$ Tn & Trailers $\geq 3,5$ Tn. Weiße Markierung nicht erlaubt am Heck.

UNECE-R104 Standard conditions for the approval of warning marking for heavy trucks and trailers. In general, white or yellow are required for the sides, yellow or red on the rear.

ECE 48 chapter 6.21 determines as where ECE 104 tape is required or not applicable at all. Mandated for trucks $\geq 7,5$ ton and Trailers $\geq 3,5$ ton. In the top corners, white ECE 104 is not allowed.

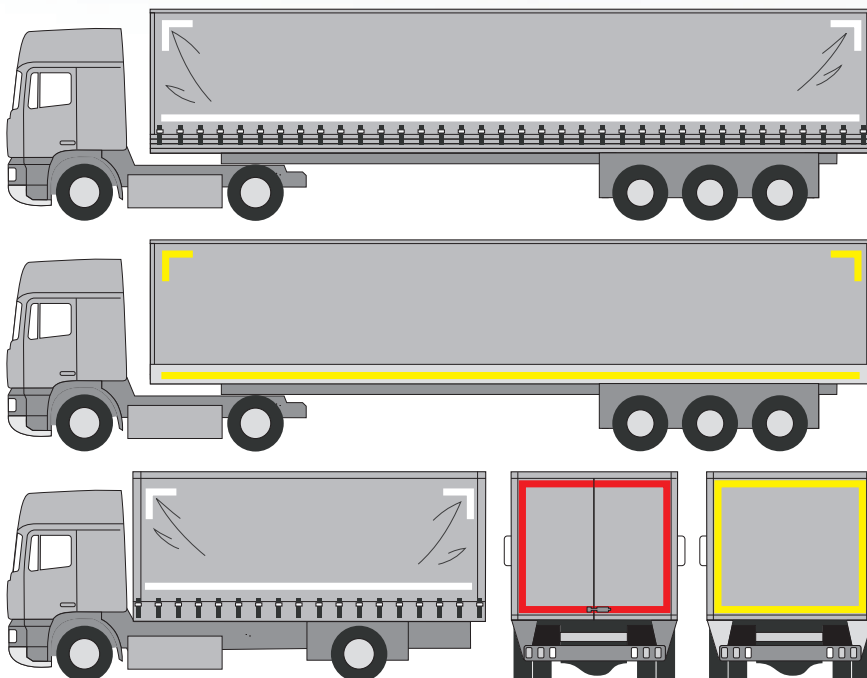

Information

UNECE R104: Einheitliche Bedingungen für Zulassung von Warnmarkierung für Fahrzeuge der Klasse M, N, und O.

Gilt nur für Warnfolien: Regelt Anforderungen an Gestaltung, Mindestflächen, Nachtfarbe, Rückstrahlwerte, Widerstand gegenüber Reinigung und Chemikalien: erlaubt;

-Fahrzeugklasse N: Fahrzeuge zur Güterbeförderung (LKW, Lieferwagen)

-N2: wovon: größer als 7,5 bis 12 Tonnen

-N3: größer als 12 Tonnen

-Fahrzeugklasse O: Anhänger und Sattelaufleger

-O2: größer als 3,5 bis 10 Tonnen

-N3: größer als 10 Tonnen

UNECE-R104 Standard conditions for the approval of warning marking for vehicles of category M, N and O.

Only applies to warning foil; Regulates design requirements, minimum surface area, night color, reflectance values, resistance to cleaning and chemicals.

Determined classes are :

-Class C strip-shaped contour marking with width = 50mm

-Class D for application on the vehicle side <math> < 2m^2 </math>

-Class E for larger applications

-Class F warning markers red / white decals (see Chapter 5, page 10-12)

Vehiclecategories :

N (trucks for transport of goods):

N2 : from 7,5-12 ton

N3: over 12 ton

O: (trailers)

O2: from 3,5 to 10 ton

O3: as of 10 ton



Einzelne Zugmaschinen (Tractor units) sind freigestellt von den Anforderungen Fest-Kabinen (Rigid units) müssen markiert werden. Ausnahme Konturmarkierung: nicht angefordert wenn Fahrzeuglänge < 6M und/oder wenn Breite < 2,1M

- Gesamtlänge des Fahrzeuges zu kleben $\geq 80\%$
- $250\text{ mm} \leq \text{Montagehöhe Linien} \leq 1500\text{ (2500)mm}$
- Markierungsabstand bis Außenseite Fahrzeuges $\leq 600\text{ mm}$
- Eckmarkierung (Tick mark): Länge $\geq 250\text{ mm}$; Position $\leq 400\text{mm}$ der äußeren Ecken

Single tractorunits do not require ECE 104. Nor trucks that are less then 6M in length and less then 2,1m in width. Trucks (rigid cabin) must comply, also must mark the cabin

- 80% of the length must be covered
- Mountingheight between 250mm and 2500mm
- Apply at least until 600mm from outer edge
- Corner-Tickmarks at least 250mm long and at least 400m from the outer edge

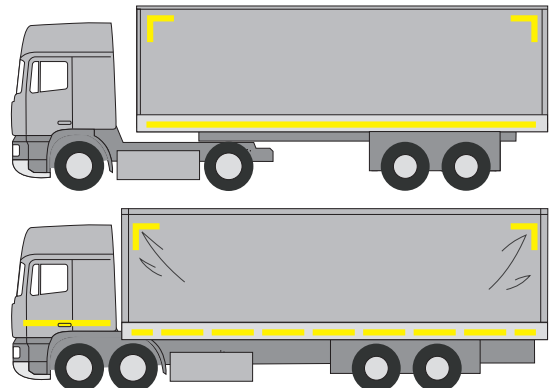

ECE 104, reguliert in ECE 48-Typgenehmigung / ECE 104, class C regulated within ECE R48

Konturmarkierungen für schwere und lange NFZ/LKW und Anhänger
StVZO §53, Absatz 10 fordert gelbe oder weiße Konturmarkierungen an der Seite, gelbe oder rote Konturmarkierungen am Heck

UNECE-R104 Standard conditions for the approval of warning marking for vehicles of category M, N and O

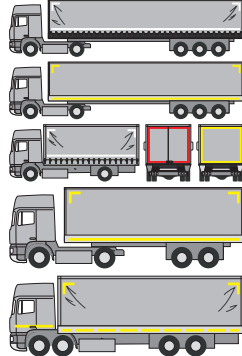

Einzelne Zugmaschinen (Tractor units) sind freigestellt von den Anforderungen
Fest-Kabinen (Rigid units) müssen markiert werden. Ausnahme Konturmarkierung:
nicht angefordert wenn Fahrzeuglänge < 6M und/oder wenn Breite < 2,1M

- Gesamtlänge des Fahrzeuges zu kleben $\geq 80\%$
- 250 mm \leq Montagehöhe Linien ≤ 1500 (2500)mm
- Markierungsabstand bis Außenseite Fahrzeuges ≤ 600 mm
- Eckmarkierung (Tick mark): Länge ≥ 250 mm; Position ≤ 400 mm der äußeren Ecken

Single tractorunits do not require ECE 104. Nor trucks that are less then 6M in length
and less then 2,1m in width. Trucks (rigid cabin) that comply,
also must mark the cabin

- 80% of the lenght must be covered
- Mountingheight between 250mm and 2500mm
- Apply at least until 600mm from outer edge
- Corner-Tickmarks at least 250mm long and at least 400m from the outer edge

Art. Nr.	Kennzeichnung / Description Selbstklebend, Rolle / Sticker roll	Abbildung / Sample
----------	--	--------------------

Festaufbau / Rigidgrade	
82.101.00	Weiß 50mmx50M White 50mmx50M
82.102.00	Gelb 50mmx50M Yellow 50mmx50M
82.103.00	Rot 50mmx50M Red 50mmx50M
82.101.125	Weiß 50mmx12,5M White 50mmx12,5M
82.102.125	Gelb 50mmx12,5M Yellow 50mmx12,5M
82.103.125	Rot 50mmx12,5M Red 50mmx12,5M



Festaufbau Tankersatz/ Rigidgrade tankerset	
Gestanzt, 160x50mm / kisscut, 160x50mm	
82.101.50T	Weiß 50mmx50M White 50mmx50M
82.102.50T	Gelb 50mmx50M Yellow 50mmx50M
82.103.50T	Rot 50mmx50M Red 50mmx50M
82.101.10T	Weiß 50mmx10M White 50mmx10M
82.102.10T	Gelb 50mmx10M Yellow 50mmx10M
82.103.10T	Rot 50mmx10M Red 50mmx10M



ECE 104, reg. in ECE 48-Typgenehmigung / ECE 104, class C reg. within ECE R48

Art. Nr.	Kennzeichnung / Description Selbstklebend, Rolle / Sticker roll	Abbildung / Sample
----------	--	--------------------

Planenfolie / Curtainingrade		
-------------------------------------	--	--

82.104.00	Weiß 50mmx50M White 50mmx50M	
-----------	---------------------------------	--

82.105.00	Gelb 50mmx50M Yellow 50mmx50M
-----------	----------------------------------

82.106.00	Rot 50mmx50M Red 50mmx50M
-----------	------------------------------

82.104.125	Weiß 50mmx12,5M White 50mmx12,5M
------------	-------------------------------------

82.105.125	Gelb 50mmx12,5M Yellow 50mmx12,5M
------------	--------------------------------------

82.106.125	Rot 50mmx12,5M Red 50mmx12,5M
------------	----------------------------------

Planenfolie, segmentiert / Curtainingrade, segmented gestanzt, 50x50mm / kisscut, 50x50mm mit Applikationstape / with transfertape		
---	--	--

82.104.50S	Weiß 50mmx50M White 50mmx50M	
------------	---------------------------------	--

82.105.50S	Gelb 50mmx50M Yellow 50mmx50M
------------	----------------------------------

82.106.50S	Rot 50mmx50M Red 50mmx50M
------------	------------------------------

Festaufbau, mit Logo (mindestens 60 Rollen) Rigidgrade, with Logo (at least 60 rolls)		
--	--	--

82.101.LOGO	Weiß 50mmx50M White 50mmx50M	
-------------	---------------------------------	---

82.102.LOGO	Gelb 50mmx50M Yellow 50mmx50M
-------------	----------------------------------

82.103.LOGO	Rot 50mmx50M Red 50mmx50M
-------------	------------------------------

Imagine

Festaufbau, mit Logo in Siebdruck (pro 6 oder 24 Rollen) Rigidgrade, with Logo in screenprint (per 6 or 24 rolls)		
--	--	--

82.101.EVO	Weiß 50mmx50M White 50mmx50M	
------------	---------------------------------	---

82.102.EVO	Gelb 50mmx50M Yellow 50mmx50M
------------	----------------------------------

82.103.EVO	Rot 50mmx50M Red 50mmx50M
------------	------------------------------

Colour Evolution

82.110.00	USA DOT-C Festaufbau/ USA DOT-C Rigidgrade Rot/weiß 50mmx45,7M Red/white 50mmx45,7M	
-----------	--	---

82.111.00	Zuschnitt rot/weiß 50mmx457mm Strip red/white 50mmx457mm
-----------	---

M MAZON



VEHICLE MARKING